

CG-30P Corner Guard

Features:

- PVC-Free materials
- Class A fire rating
- "Surface Mount" installation follows completion of drywall mounting
- Stock lengths: 4'-0" (1219), 8'-0" (2438), 9'-0" (2743), 1'-0" (3048), and 12'-0" (3658)
- Custom cut lengths available
- Standard with textured top and bottom closure caps

Finishes:

- Snap-on cover (textured)
 - Manufacturer's standard colors
 - Custom colors available
- Aluminum retainer
 - Mill finish #405

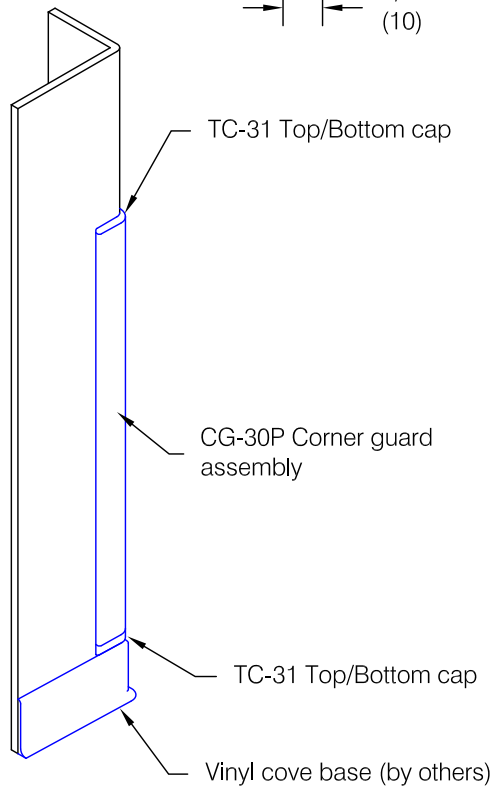
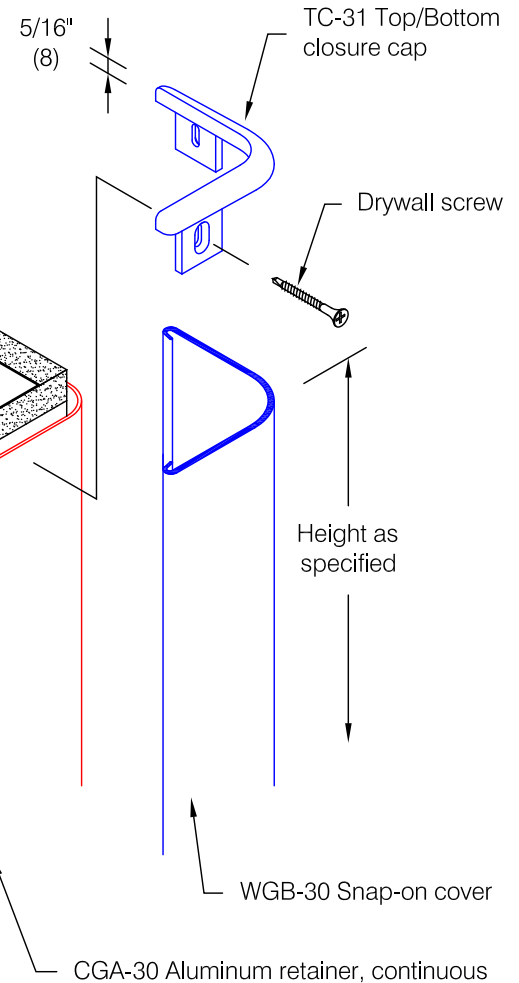
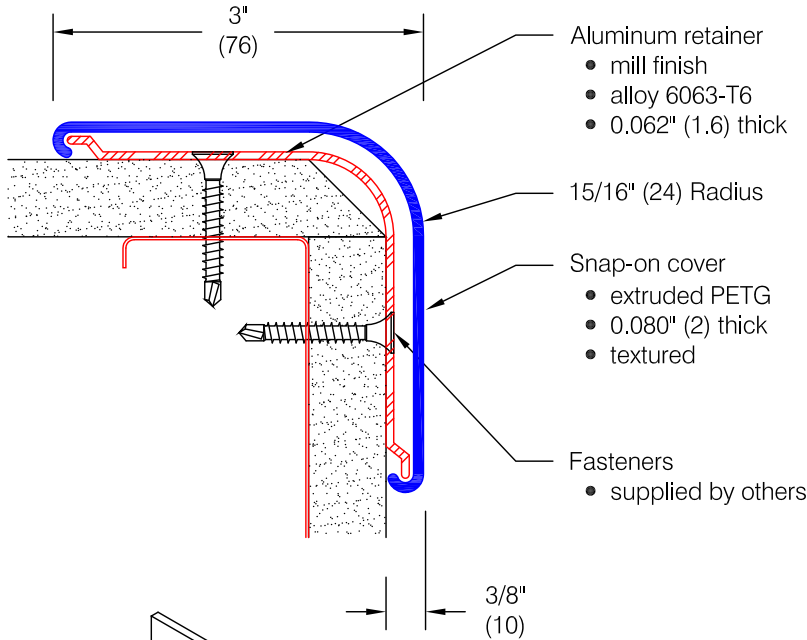

Application Diagram

* Partial height installation with top and bottom caps shown. Full height installations may not require top or bottom cap.

Pawling Corporation reserves the right to discontinue a design or modify an existing design without prior notice

Customer :	Project :	WD.106P.0
Architect :	Sales Rep :	