



www.pawling.com

PAWLING

CORPORATION

ARCHITECTURAL PRODUCTS

BUILDING CATALOG



Why Choose Pawling?

With over seventy years of experience, Pawling Corporation is a leading manufacturer of high-quality architectural products that will meet your material specifications as well as your design needs. We offer responsive, results-oriented design capabilities to satisfy any custom design requirement.

- *Complete line of impact protection, entrance mats, athletic tile and parking products to protect your entire facility in any application*
- *Broad line of exceptional products to protect facilities front to back, inside and outside*
- *Custom-designed fabrications and colors based on your needs*

www.pawling.com

PAWLING

CORPORATION



TABLE OF CONTENTS

ALPAR/PRO-TEK NXT® AND RAPID RESPONSE



Alpar/Pro-Tek NXT® Products..... (4)
Rapid Response Products..... (5)

IMPACT PROTECTION



Handrails..... (6)
Corner Guards..... (14)
Wall Guards..... (22)
Wall Covering..... (30)
Door and Frame Protection..... (32)
Equipment and Cart Bumpers..... (36)

PARKING AND TRAFFIC SAFETY



Vehicular Control /Impact Protection.... (40)

HEAVY-DUTY PROTECTION

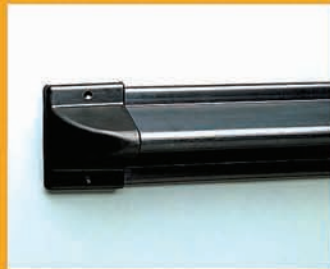

Heavy-Duty Bumpers..... (46)
Heavy-Duty Corner Guards..... (51)

ATHLETIC FLOORING



Interlok® Tiles..... (58)
Recycled Rubber Tiles..... (61)

ENTRANCE MATTING



Rol-Dek®..... (64)
Drain Well®..... (66)
Heavy-Duty Rubber Entrance Mats..... (68)
Metal Gratings..... (69)
Heavy-Duty Carpets..... (70)
Vinyl Entrance and Vinyl Backed Mats... (72)

*Color selection guides are located on page 54, 62 & 73.

alpar Pro-Tek® NXT

Protecting the environment while providing the same level of Impact Protection.



About our PETG products:

Pawling is pleased to announce our new line of PVC free impact protection products created from a PETG compound. Pro-Tek® NXT is made from a BPT free, class A, non-halogenated fire retardant material. It is available in all our 70 standard colors with custom color matching to allow for vast design possibilities.

Alpar products:

Pawling Corporation's subsidiary, Alpar Architectural Products, offers wall and corner guards and sheet wall protection made from a variety of environmentally friendly materials including DeTerra® biobased polymer. DeTerra® biobased polymer is the construction industry's only fire-rated, biobased polymer and is made from more than 90% rapidly renewable materials.

- CORNER GUARDS
- WALL COVERING
- WALL GUARDS
- HANDRAILS



RAPID RESPONSE

Your planner forgot five corner guards in your project. Ten feet of wall guard needs replacement in the pediatric wing. You didn't think you'd need a handrail in that hallway, but now you realize you do. When you need almost instant wall protection, think Pawling and our Rapid Response program. We ship it in three days. Just look for the  icon on our hand rails, corner guards, wall guards, and sheet wall covering, available in eight of our most popular colors. It's our guarantee and proof that we want to meet and exceed your expectations.

Need it quick?
That's what Rapid Response is for - contact your Pawling representative today for more information or log on to www.pawling.com

AVAILABLE COLORS



*Rapid Response wall guard, handrail, and corner guard orders are limited to a maximum of 50 pieces per profile, per color, in standard sizes listed. Wall covering orders are limited to 4' x 8' sheets and a maximum of two cases per thickness and color. CG-50 and CG-51 stainless steel corner guards are available undrilled in 4 foot lengths, 16 gauge type 304 stainless with a satin finish.

WG-4



WG-6, WG-6C



WG-8, WG-8C



BR-1200



BR-500



CG-10, CG-10R



CG-50, CG-51



CG-20, CG-20R



CG-17, CG-18



CGU-12



WC-40, WC-60

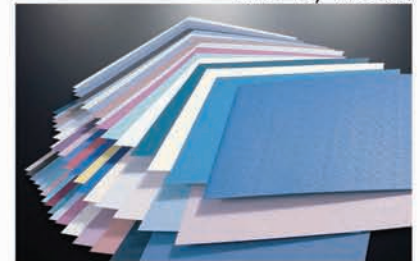

HANDRAILS

Pro-Tek® Handrails run the gamut of sizes, shapes, colors and styles. In addition to our unique ability to protect all areas of any facility, the design flexibility of these products is limitless. We offer outstanding protection, thus dramatically reducing maintenance and repair expenses. Choose from rectangular or curved profiles, many with design options such as grooved surfaces, 70 standard colors and custom color matching. And our Red-E-Clip® installation option will stretch your budget by using a lightweight yet equally durable product that installs more quickly and easily than traditional aluminum retainers.



BR-600V

A uniquely attractive oval handgrip and Crescent® bumper guard highlights this handrail. Coordinate your facility design using BR-600V and our WG-5 and WG-7 Crescent® wall guards, all three of which offer unlimited design options.

*Available with 2" international bracket offset.

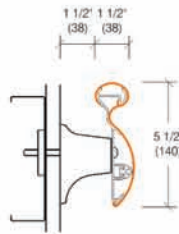

Dimensions: 1-1/2"D x 5-1/2"H

Protection Level: Medium-Heavy

Continuous Security Bracket: Yes



BR-600C

Our BR-600C Crescent® handrail offers an attractive wood grip in up to 24 choices of wood and stain combinations. Wood brings an element of contrast and warmth to the vinyl bumper.

*Available with 2" international bracket offset.

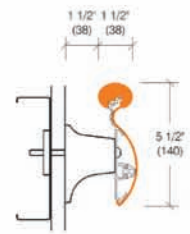

Dimensions: 1-1/2"D x 5-1/2"H

Protection Level: Medium-Heavy

Continuous Security Bracket: Yes





BR-530,532,530X,530G

Our Endura Rail features the only aluminum reinforced return in the industry. Also available with a 2-1/4" co-extruded accent stripe (BR-532), co-extruded accent lines (BR-530X), or horizontal grooves (BR-530G), this series combines a nearly indestructible handrail with design flexibility.

*Available with 2" international bracket offset.

Dimensions: 1-1/2"D x 5-1/2"H

Protection Level: Heavy

Continuous Security Bracket: Yes

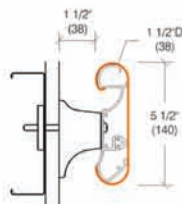

BR-500,500G,502

A universal handrail for all applications. Choose a smooth surface or the addition of grooves for added detail (BR-500G). Like the BR-530, the continuous security bracket is also available.

*Available with 2" international bracket offset.

Dimensions: 1-1/2"D x 5-1/2"H

Protection Level: Medium-Heavy

Continuous Security Bracket: Yes

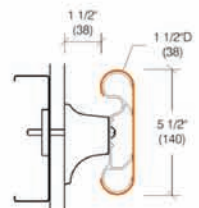

BR-400V,400VG

This three-piece vinyl assembly allows for thousands of color combinations of the handrail, guardrail and enhancing thumb rail stripe in an attractive, durable design. The BR-400VG adds horizontal grooved accent lines on the lower guardrail for added texture and design contrast. Combine with WG-6 wall guard for a consistent presentation.

*Available with 2" international bracket offset.

Dimensions: 1-1/2"D x 6-1/4"H
 Protection Level: Medium-Heavy
 Continuous Security Bracket: Yes

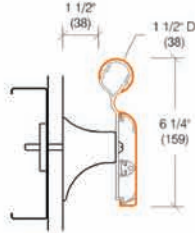

BR-400C,400CR,400CG

Powerful and attractive - another profile that provides a myriad of design options with the handrail strength you need. An attractive wood handrail and thousands of color combinations for the vinyl guardrail and enhancing thumb strip, BR-400C, CR (Removable Wood Top), and CG (Grooved Bumper Rail) provide added richness to any design.

*Available with 2" international bracket offset.

Dimensions: 1-1/2"D x 6-1/4"H
 Protection Level: Medium-Heavy
 Continuous Security Bracket: Yes

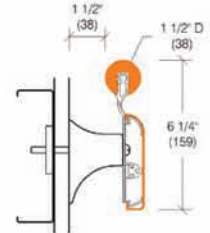

BR-400W

This attractive wood handrail and wall guard combination, with a design-enhancing thumb rail stripe in any of our 70 standard colors, provides safety, support and protection in a stylish, rich profile. Two black horizontal bumpers on the wall guard add contrast and durability with extra protection from scratches.

*Available with 2" international bracket offset.

Dimensions: 1-1/2"D x 6-1/4"H
 Protection Level: Medium
 Continuous Security Bracket: Yes

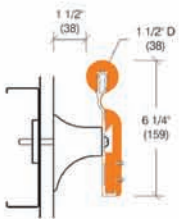

BR-800

This simple profile has flex-action to fully absorb impact, making it ideal as both a handrail and crash rail. Match the BR-800 with our WG-30 wall guard for a coordinated design.

Dimensions: 1-1/2"D x 5-3/8"H
 Protection Level: Medium-Heavy
 Continuous Security Bracket: No

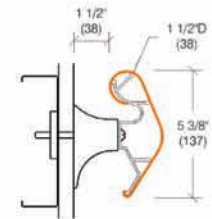

BR-1600S

Stylish stainless steel hand rail, returns, corners and mounting brackets.
1-1/2" round profile.

*Available with 2" international bracket offset.

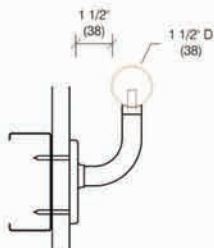

Dimensions: 1-1/2"D
Protection Level: Medium
Continuous Security Bracket: No



BR-1200

For a good power grip, choose the BR-1200 with a 1-1/2" diameter rail. Function, durability and affordability highlight this traditional handrail design.

*Available with 2" international bracket offset.

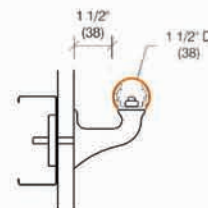

Dimensions: 1-1/2"D
Protection Level: Medium
Continuous Security Bracket: No



BR-1600

Add a touch of class to your wood handrail with our stylishly contrasting stainless steel returns, corners and mounting brackets.
1-1/2" round profile.

*Available with 2" international bracket offset.

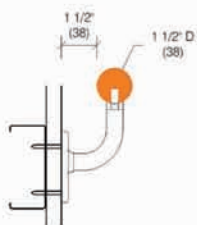

Dimensions: 1-1/2"D
Protection Level: Medium
Continuous Security Bracket: No



BR-2400

Ideal for healthcare, elder care or childcare facilities, these dual rails provide excellent grip location whether standing or sitting.

Dimensions: 1-1/2"D
Protection Level: Medium
Continuous Security Bracket: No

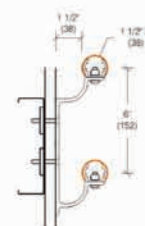

BR-3500

Solid wood handrail adds style, provides safety, while maintaining a natural look.

*Available with 2" international bracket offset.

Dimensions: 1-1/2" D x 3-1/2" H

Protection Level: Medium

Continuous Security Bracket: Yes

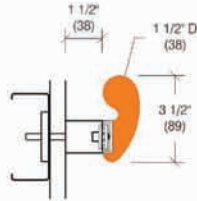

BR-5500

A beautiful wood handrail/crash rail system with a flexible bumper for added protection. Four species of wood, each in six standard stain colors, 12 standard bumper colors and limit-less custom colors.

*Available with 2" international bracket offset.

Dimensions: 1-1/2" D x 5-1/2" H

Protection Level: Medium

Continuous Security Bracket: Yes

12 bumper colors available: (White Sand, Eggshell, Ivory, Desert Sand, Tan, Beige Desert, Cordovan, Sage Green, Hunter Green, Windsor Blue, Blue Bird and Black)

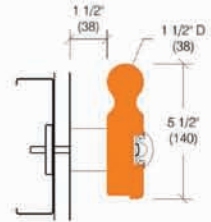

Foundation™ Series Handrails



Pawling's Foundation™ Series handrail offers the Architect and Designer the versatility and flexibility to "build" the look they desire by selecting from a variety of shapes and materials to be featured on a versatile powder coated metal bracket (see our powder coat finishing choices on Page 57).

Combine a round or oval handgrip in real wood or vinyl with a 4" bumper guard in real wood, vinyl, or stainless steel. This will provide superior functionality and impact protection in a wide range of aesthetics within hospitals, nursing homes, offices, and all types of different facilities. The Foundation™ Series offers Pawling's outstanding excellence in performance, design, and functionality.

BR-4RWW, BR-4EWW

Foundation Series handrail offers versatility and flexibility by "building" the look you desire. Features: ADA Compliant, Wall returns - with hardware, Outside corners - with hardware, Inside corners - mitered

*BR-4RWW-round handrail, BR-4EWW-oval handrail.

*Available with 2" international bracket offset.

Stock Lengths: Wood - Random 6'-0" (1829) to 16'-0" (4877), and Aluminum: 12'-0" (3658)

Bracket: Powder coated aluminum with concealed wall mount hardware.

Custom woods and stain colors available.

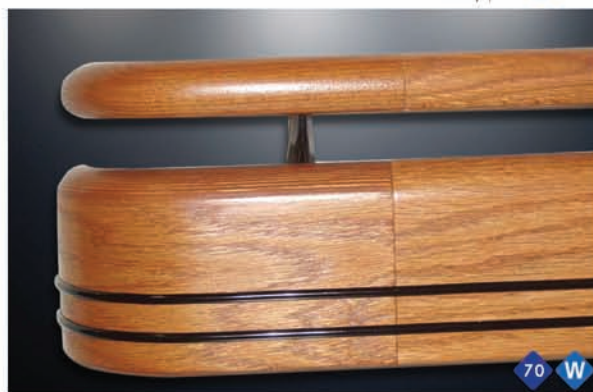
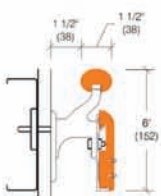
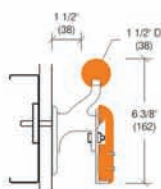

BR-4RVV, BR-4EVV

Foundation Series handrail offers versatility and flexibility by "building" the look you desire. Features: ADA Compliant, Class A fire rating, Molded returns - with hardware, Molded outside corners - with hardware.

*BR-4RVV-round handrail, BR-4EVV-oval handrail.

*Available with 2" international bracket offset.

Stock Lengths: 12'-0" (3658)

Bracket: Powder coated aluminum with concealed wall mount hardware.

Custom colors available.

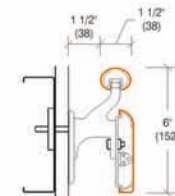
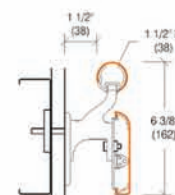

BR-4RSS

Pre-fabricated stainless steel bottom rail with a stainless steel top rail.

Stock Lengths: 10' Stock Length

Bracket: Stainless Steel

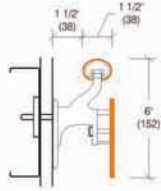

*Available with 2" international bracket offset.



BR-4RWV, BR-4E WV

Foundation Series handrail offers versatility and flexibility by "building" the look you desire. Combine a round wood handgrip with a 4" vinyl bumper. Features: Wood, Wall returns - with hardware, Outside corners - with hardware

*BR-4RWV-round handrail. BR-4E WV-oval handrail.

*Available with 2" international bracket offset.

Stock Lengths: Wood: random 6'-0" (1829) to 16'-0" (4877). Crash rail: Vinyl Bumper 12' lengths

Bracket: Powder coated aluminum with concealed wall mount hardware

Custom woods and stain colors available.

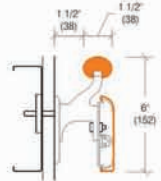
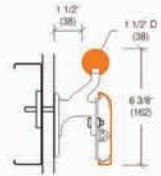

BR-4RVW, BR-4EVW

Foundation Series handrail offers versatility and flexibility by "building" the look you desire. Features: ADA Compliant, Class A fire rating, Molded returns - with hardware, Molded outside corners - with hardware

*BR-4RVW-round handrail. BR-4EVW-oval handrail.

*Available with 2" international bracket offset.

Stock Lengths: Wood - random 6'-0" (1829) to 16'-0" (4877), Aluminum or Vinyl: 12'-0" (3658)

Bracket: Powder coated aluminum with concealed wall mount hardware

Custom woods and stain colors available.

Custom vinyl colors also available.

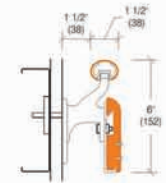
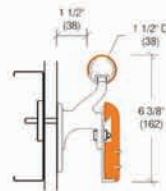

BR-4RWS, BR-4EWS

Foundation Series handrail offers versatility and flexibility by "building" the look you desire. Features: Wood, Wall returns - with hardware, Outside corners - with hardware

*BR-4RWS-round handrail. BR-4EWS-oval handrail.

*Available with 2" international bracket offset.

Stock Lengths: Wood: random 6'-0" (1829) to 16'-0" (4877). Crash rail: stainless steel, type 304, chamfered edges, #4 satin finish

Bracket: Powder coated aluminum with concealed wall mount hardware

Custom woods and stain colors available.

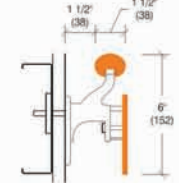
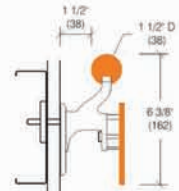



CORNER GUARDS

Pawling's line of corner guards leads the industry in its breadth of application, with suitable options for protecting every type of facility and every application. You can rely on Pawling's Pro-Tek® corner guards to protect your building from front to back. Choose from flush-mounted or surface-mounted corner guards with styles including vinyl retainers, rigid vinyl, polycarbonate, stainless steel, aluminum, rubber and recycled HDPE. Most styles are available in multiple sizes, angles, and colors for perfect coordination with the rest of our impact protection product line.



CG-10,10R

CG-10 is our 90° surface mounted vinyl corner guard. The standard CG-10 comes with an aluminum retainer while the CG-10R uses a recycled vinyl retainer. Available in custom colors and custom angles.

Wing Dimension	Style	Corner Protection
3"	90°	Medium-Heavy



CG-20,20R

For areas with less traffic, our 2" wing corner guard provides the protection needed in a size designed to blend easily into your décor. Our standard CG-20 has an aluminum retainer and our CG-20R has a recycled vinyl retainer. Custom colors and custom angles available.

Wing Dimension	Style	Corner Protection
2"	90°	Medium-Heavy



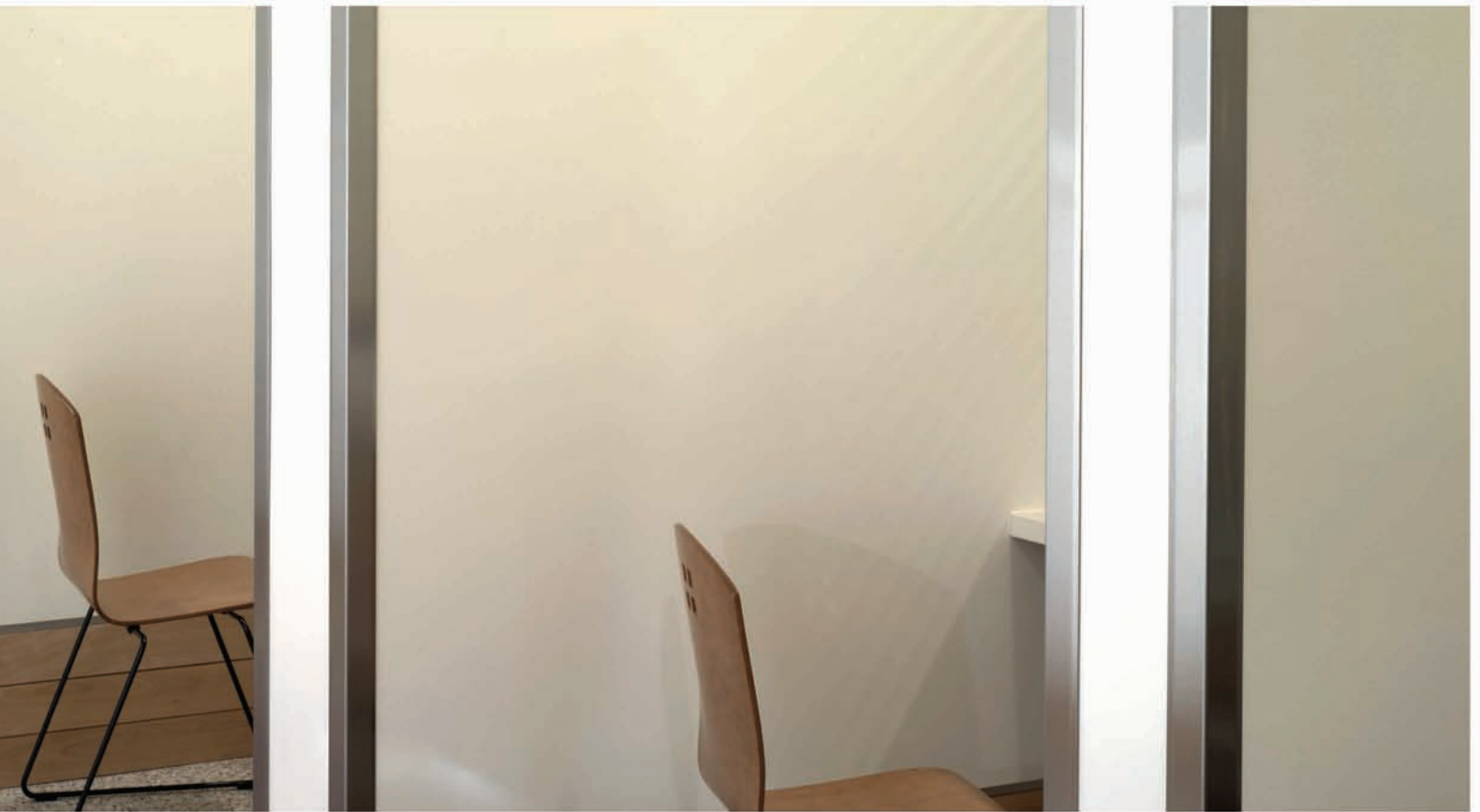

CG-30

Our bull nose 3" wing corner guard provides effective protection with a smooth, rounded corner for great design flexibility.

Wing Dimension	Style	Corner Protection
3"	90°	Medium-Heavy

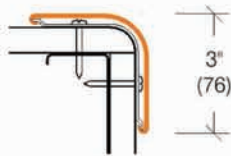

70

CG-135, 135R

The CG-135 is our 3" wing vinyl corner guard with a 135° angle and aluminum retainer. Also available with a recycled vinyl retainer (CG-135R).

Wing Dimension	Style	Corner Protection
3"	135°	Medium-Heavy

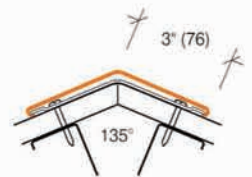

70



CG-34,12,13,14,124

Our rigid vinyl corner guards come in 90° or 135° angles and wing sizes from 3/4" to 4". The smallest wing (CG-34) is installed with double-faced tape or adhesive, but all other styles come with the option of adhesive, double-sided tape or mechanical fasteners using pre-drilled holes.

Product Code	Wing Dimension	Style	Corner Protection	Available Colors
CG-34	3/4"	90°	Medium	
CG-12	1-1/2"	90°	Medium	
CG-13	3"	90°	Medium	
CG-14	4"	90°	Medium	
CG-1245	1-1/2"	135°	Medium	

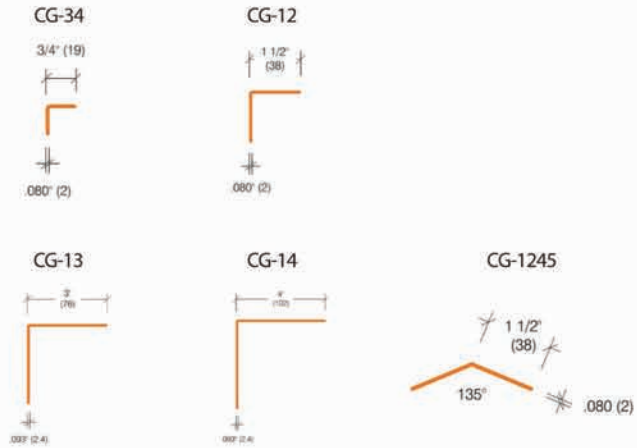
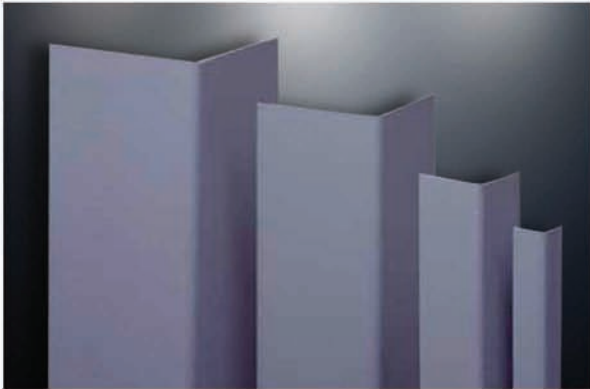

CG-16,17,18,19,23,24,25

Our clear polycarbonate corner guards allow your décor to shine through. Or choose from nine additional color options. With three angles, two wing sizes and two standard lengths (4' or 8'), these corner guards provide a medium level of protection with numerous design choices.

*Custom lengths also available.

Product Code	Wing Dimension	Style	Available Colors for All
CG-16	3/4"	90°	 Clear, Black, Ivory, Linen, White, Tan, Brown, Gray, Green, Pastel Blue, Polar White
CG-17	1-1/8"	90°	
CG-18	2-1/2"	90°	
CG-19	2-1/2"	135°	
CG-23	2-1/2"	90° 1/2" radius	
CG-24	2"	90°	
CG-25	3"	90°	

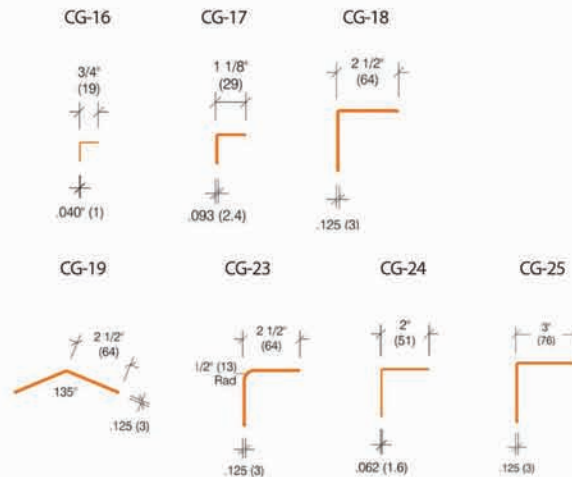

CG-50,51,52,55,60,65

Our stainless steel corner guards are completely customized with a variety of stainless types and thickness, as well as custom wing sizes, angles, and radii. Combine with our CRS-100 for a coordinated stainless steel design that provides heavy duty impact protection. Installation is easy with our standard adhesive or optional pre-drilled holes for fasteners.

Product Code	Wing Dimension	Style	Corner Protection	Available Material for all
CG-50	3-1/2"	90°	Heavy	#4 Satin Finish Stainless Steel
CG-51	2"	90°	Heavy	
CG-52	1"	90°	Heavy	
CG-55	3-1/2"	90° 3/4" radius	Heavy	
CG-60	3-1/2"	135° 1/8" radius	Heavy	
CG-65	3-1/2"	135° 3/4" radius	Heavy	

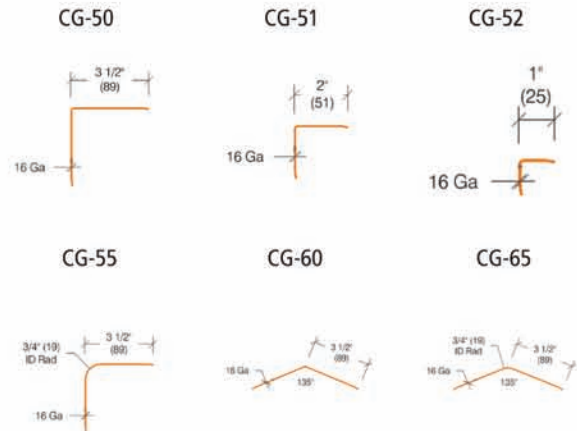

CG-400,401,402,403,404,405

Our mill finish aluminum corner guards are easy to install and come in wing sizes from 1" to 3". They come standard with adhesive, or can be pre-drilled for mounting with mechanical fasteners. Customize the look you need with lengths up to 10'. Also available in custom angles and wing sizes.

CG-401, 402, 404, 405 are available in our new 3003 Aluminum Diamond Tread Plate texture.

Product Code	Wing Dimension	Style	Corner Protection	Available Material for All
CG-400	1"	90°	Heavy	Mill Finish Aluminum
CG-401	2"	90°	Heavy	
CG-402	3"	90°	Heavy	
CG-403	1"	135°	Heavy	
CG-404	2"	135°	Heavy	
CG-405	3"	135°	Heavy	

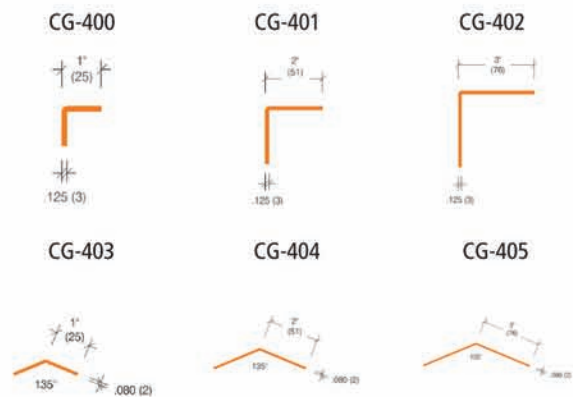

CG-11,11R

Our CG-11 gives your end wall partitions extra protection with two CG-20 2" wing corner guards with aluminum retainers and our rigid wall covering strip as filler. Also available with a recycled retainer (CG-11R).

Wing Dimension	Style	Corner Protection
2" wings; can fit partition up to 9" wide	End Wall	Medium-Heavy

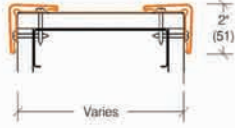

CGWS-275, CGWS-275-135

A refined wood profile with a sturdy stainless steel insert to deflect tough impacts. 90° or 135° angles, each with a top and bottom stainless steel cap. Material: Type 304 or 430 Stainless Steel with #4 Satin Finish



Product Code	Wing Dimension	Style	Corner Protection
CGWS-275	2-3/4"	90°	Medium
CGWS-275-135	2-3/8"	135°	Medium

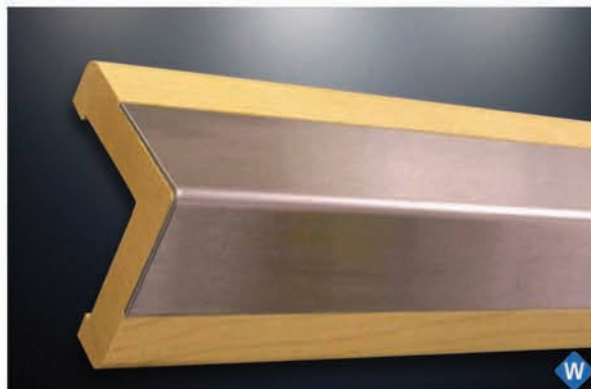

CG-888

This custom fabricated end wall protector can be fitted for partitions up to 7-1/4" wide. Two internal bumpers offer the impact absorption necessary for vulnerable end wall partitions. Cove-base Installation / Aluminum Insert Flush mounted.

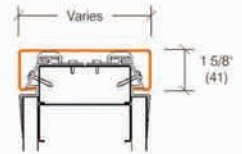

Wing Dimension	Style	Corner Protection
1-5/8"	End Wall	Med.-Heavy

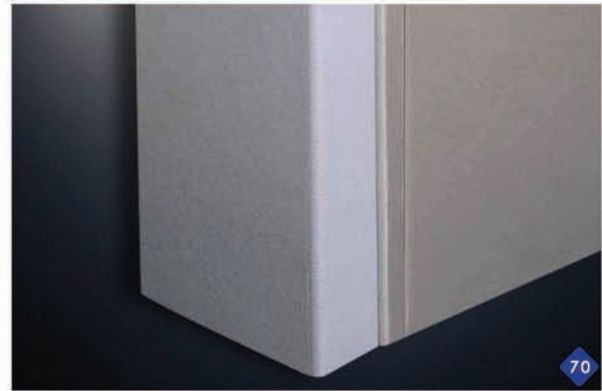

CGWS-275B

Refined wood profile with a bullnose, sturdy stainless steel insert. Material: Type 304 or 430 Stainless Steel with #4 Satin Finish

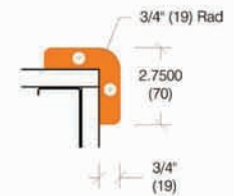

Wing Dimension	Style	Corner Protection
2-3/4"	90°	Heavy



CG-7,72

Standard angles for our 3" and 2" wing corner guards are 90°, but we will custom fabricate flush-mounted corner guard to any angle required from 45° to 160°.
Cove-base Installation / Aluminum Insert

Product Code	Wing Dimension	Style	Corner Protection
CG-7	3"	90°	Med-Heavy
CG-72	2"	90°	Med-Heavy

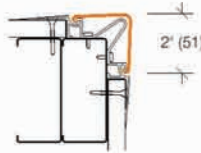

CG-7S,72S

Flush mounted stainless steel corner guard. A perfect pair to our Steri-guard™ (CRS-100).
Material: Type 304 or 430 Stainless Steel with #4 Satin Finish
Cove-base Installation / Aluminum Insert

Product Code	Wing Dimension	Style	Corner Protection
CG-7S	3"	90°	Heavy
CG-72S	2"	90°	Heavy

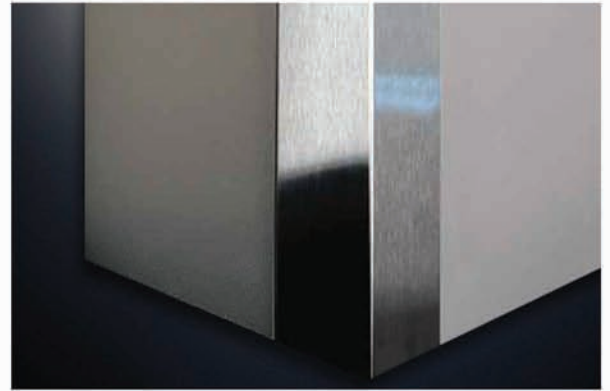
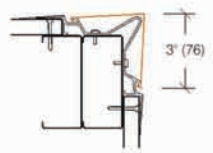

CG-75

Offers same protection as CG-7, but with 135° angle.
Cove-base Installation / Aluminum Insert
Flush mounted.

Wing Dimension	Style	Corner Protection
3"	135°	Med-Heavy



CG-32

For a softer more gradual corner. The bullnose CG-32 has a 90° corner with a 15/16" radius cover. The "flex action" of the vinyl cover deflects energy and helps absorb impact.
Cove-base Installation / Aluminum Insert
Flush mounted.

Wing Dimension	Style	Corner Protection
3"	90° Bull-nose	Med-Heavy

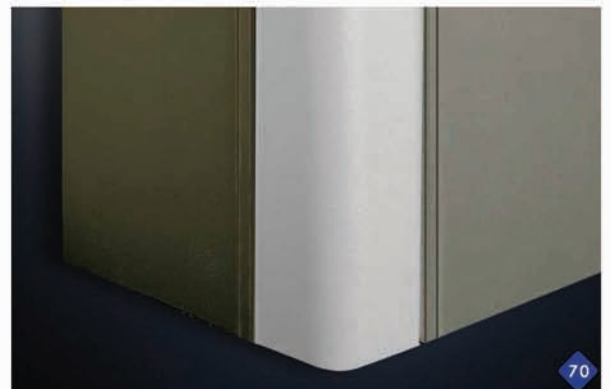
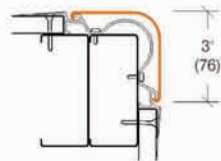

CGF-7,72

Our flush-mounted corner guards with fire barriers will protect your corners, and help protect your patients, tenants or employees from fire, with 3" or 2" wings.

Cove-base Installation / Aluminum Insert

Fire Rating:

1 layer dry wall = 1 hour

2 layers drywall = 2 hours

Product Code	Wing Dimension	Style	Corner Protection
CGF-7	3"	90°	Med-Heavy
CGF-72	2"	90°	Med-Heavy

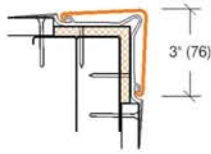

CGF-32

For a softer, more gradual corner, use our bullnose CG-32 90° corner guard with a 15/16" radius corner. The "flex action" of the vinyl cover deflects energy and helps absorb impact.

Cove-base Installation / Aluminum Insert

Flush mounted.

Fire Rating:

1 layer dry wall = 1 hour

2 layers drywall = 2 hours

Wing Dimension	Style	Corner Protection
3"	90° 15/16" radius	Med-Heavy

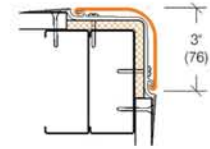

CGF-75

CG-75 offers the same protection as CG-7, but with a 135° angle.

Cove-base Installation / Aluminum Insert

Flush mounted.

Fire Rating:

1 layer dry wall = 1 hour

2 layers drywall = 2 hours

Wing Dimension	Style	Corner Protection
3"	135°	Med-Heavy

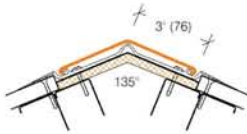

CGF-888

CGF-888 is custom made to your wall dimensions, up to 7-1/4" wide, for a perfect fit.

Cove-base Installation / Aluminum Insert

Flush mounted.

Fire Rating:

1 layer dry wall = 1 hour

2 layers drywall = 2 hours

Wing Dimension	Style	Corner Protection
1-5/8"	End Wall	Med-Heavy

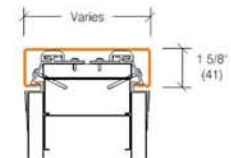

CG-500,500A,500EW,510,510A,500EW,525,525A,525EW

Our stainless steel flush mount corner guards are easy to install and provide a heavy protection level. Standard installation is pre-drilled for mounting with mechanical fasteners with an optional mounting with adhesive. Customize the look you need with stock lengths of 4' & 8'. We are able to accommodate custom angles and wing sizes to fit your design requirements as well. Available as type 304 or 430 stainless steel with #4 satin finish, these corner guards are also available in aluminum."



Product Code	Wing Dimension	Style	Corner Protection	Available Material
CG-500	3-1/2"	90°	Heavy	StainlessSteel
CG-500A	3-1/2"	90°	Medium	Aluminum
CG-510	2"	90°	Heavy	StainlessSteel
CG-510A	2"	90°	Medium	Aluminum
CG-525	1-1/2"	90°	Heavy	StainlessSteel
CG-525A	1-1/2"	90°	Medium	Aluminum
CG-500EW	3 1/2"	Endwall	Heavy	Stainless Steel
CG-510EW	2"	Endwall	Heavy	Stainless Steel
CG-525EW	1-1/2"	Endwall	Heavy	Stainless Steel

CG-500/500A

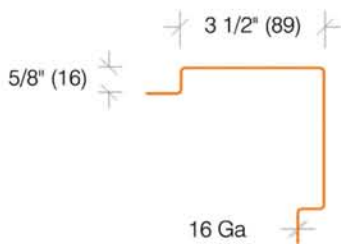

CG-510/510A

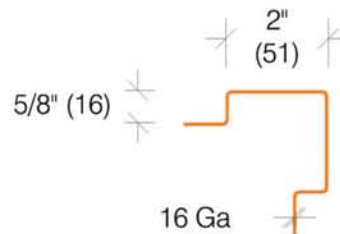

CG-525/525A

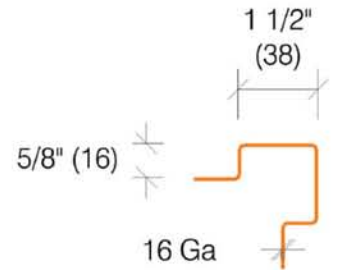

CG-500EW

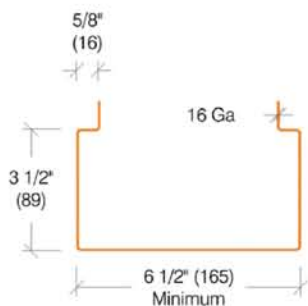

CG-510EW

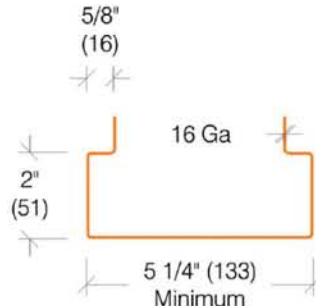

CG-525EW

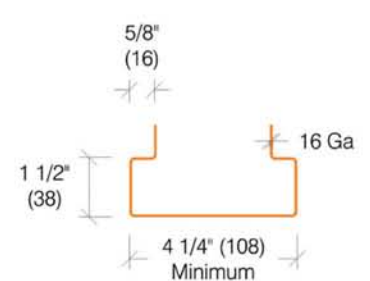

WALL GUARDS

Pro-Tek® wall guards run the gamut of sizes, shapes, colors and styles. In addition to our unique ability to protect all areas of any facility, the design flexibility of these products is limitless. We offer outstanding protection, thus dramatically reducing maintenance and repair expenses. Choose from rectangular or curved profiles, many with design options such as grooved surfaces, 70 standard colors and custom color matching. And our Red-E-Clip® installation option will stretch your budget by using a lightweight yet equally durable product that installs more quickly and easily than traditional aluminum retainers.



WG-3, WGG-3

This versatile wall guard can be used as a wainscot cap, chair rail or crash rail. Multiple rows can provide maximum impact protection and decorative appeal. Also available with horizontal grooves (WGG-3).

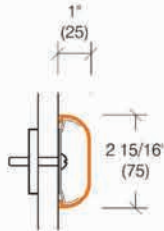

Dimensions: 1"D x 2-15/16"H

Protection Level: Medium

Retainer: Continuous Aluminum



70

WG-4, WGG-4

This versatile wall guard can be used as a wainscot cap, chair rail or crash rail. Multiple rows can provide maximum impact protection and decorative appeal. Also available with horizontal grooves (WGG-4).

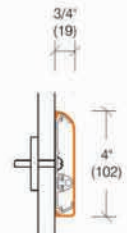

Dimensions: 1"D x 4"H

Protection Level: Medium

Retainer: Continuous Aluminum



70

RR

RR WG-4 ONLY



WG-6,6C,WGG-6,6C,WGX-6,6C

Versatile and durable, this wall guard gives a natural, congruous feel when combined with the BR-500 handrail. Also available with horizontal grooves (WGG-6) or co-extruded accent lines (WX-6), this durable wall guard is available with our Red-E-Clip.

Dimensions: 1"D x 6"H

Protection Level: Medium

Retainer: Continuous Aluminum

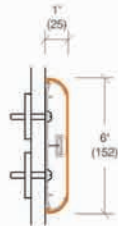

RR WG-6,6C ONLY

WG-8,8C,WGG-8,8C

Our most popular wall guard product, WG-8 offers heavy-duty impact protection for a larger surface area. The WG-8 is also available with our Red-E-Clip system and can also be manufactured with horizontal grooves (WGG-8).

Dimensions: 1"D x 7-3/4"H

Protection Level: Medium

Retainer: Continuous Aluminum

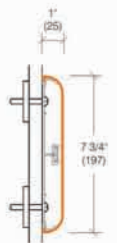

RR WG-8.8C ONLY

WG-12

Pawling's largest wall guard utilizes two internal rubber bumpers to fully absorb impact. Two sets of horizontal grooves bring added interest to this distinctive design. WG-12 is ideal for headwall protection in rooms requiring maximum protection.



Dimensions: 2"D x 12"H

Protection Level: Heavy

Retainer: Continuous Aluminum



CR-40,60

Fabricated from our .040" and .060" gauge wall covering, these Class A fire rated rub rails are available in a height of 4", 6", and 8".

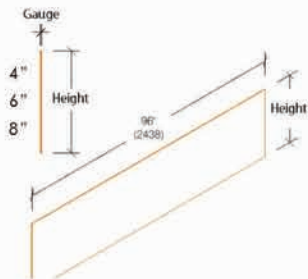

WG-5,5C

Our Crescent® series has an appealing, gentle shape offering a fresh alternative to traditional rectangular designs. Add WG-7 and BR-600 handrails for a coordinated design package. WG-5 has a continuous aluminum retainer while the WG-5C uses our Red-E-Clip.

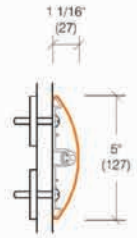

Dimensions: 1-1/16"D x 5"H

Protection Level: Medium-Heavy



WG-7,7C

This stylish Crescent® shape with an 8" high profile protects wall surface. Combining WG-7 with our other Crescent® rails (WG-5 and BR-600) spawns aesthetically appealing design options. WG-7 has a continuous aluminum retainer while the WG-7C uses our Red-E-Clip.

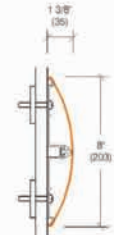

Dimensions: 1-3/8"D x 8"H

Protection Level: Medium-Heavy



WG-30

The WG-30 design adds visual depth and extended protection as a stand-alone crash rail or as a low bumper rail beneath our BR-800 handrail. WG-30 comes standard with 1/2" rubber spacers to extend it off the wall.

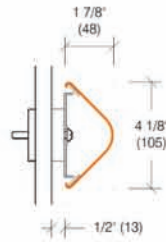

Dimensions: 1-7/8"D x 4-1/8"H

Protection Level: Medium-Heavy

Retainer: Continuous Aluminum



70

WG-35

This attractive, sculpted 'shell' design in heavy-duty rigid vinyl helps shield surfaces from wheeled and pedestrian traffic and abuse.

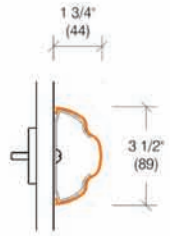

Dimensions: 1-3/4"D x 3-1/2"H

Protection Level: Medium-Heavy

Retainer: Continuous Aluminum



70

BB-4

Effectively absorbs impact abuses by cleaning and other equipment with this 4" baseboard profile. The color choices coordinate and compliment all other Pro-Tek® wall and corner guard products.

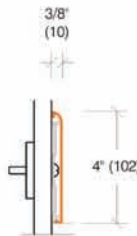

Dimensions: 3/8"D x 4"H

Protection Level: Heavy

Retainer: Continuous Aluminum



70

BL-4

Our uniquely designed bed bumper corrals beds into place while protecting patient room headwalls. It also creates needed space for IV racks and patient monitors by keeping beds away from the wall. Available with or without optional mounting bracket.

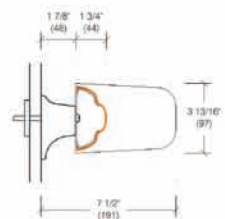

Dimensions: 7-1/2"D x 3-13/16"H

Protection Level: Medium-Heavy

Retainer: Continuous Aluminum



70

WB-4

A rich wood frame combines with our rugged WG-4 for definitive beauty and impact protection. Choose from our standard 70 colors of wallguard and 6 stain colors to integrate an attractive wood wallguard into any design.

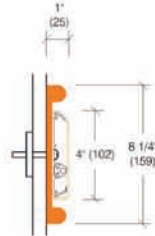

Dimensions: 7/8"D x 6-1/4"H

Protection Level: Medium-Heavy

Retainer: Continuous Aluminum



CRW-10

This sculpted wood chair rail mirrors the shape and style of our BR-400W handrail. Two understated rubber strips offer additional protection and visual interest.

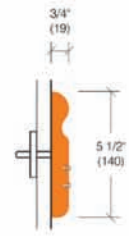

Dimensions: 3/4"D x 5-1/2"H

Protection Level: Medium-Heavy

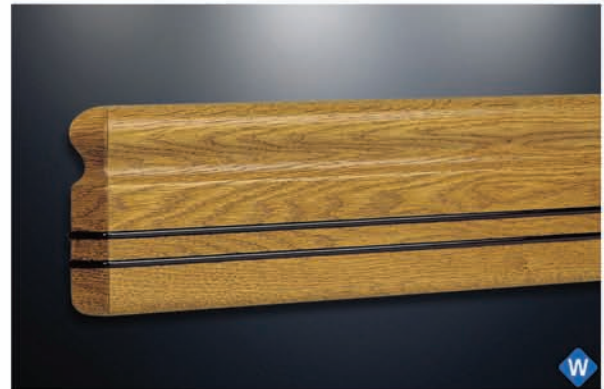

CRW-20

CRW-20 provides the perfect mate for our BR-5500 wood handrail in both shape and style, with the same flexible bumper for added durability.



Dimensions: 3/4"D x 5-1/2"H

Protection Level: Medium-Heavy

12 bumper colors available: (White Sand, Eggshell, Ivory, Desert Sand, Tan, Beige Desert, Cordovan, Sage Green, Hunter Green, Windsor Blue, Blue Bird and Black)



CRW-30

Our CRW-30 wood wall guard presents a smaller wood wall guard design that is perfect for hotel corridors or conference room chair rails. The flexible bumper insert provides attractive, durable protection against service carts and chairs.

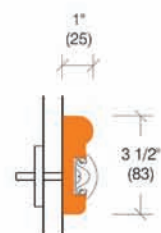

Dimensions: 1-1/8"D x 3-1/4"H

Protection Level: Medium-Heavy

12 bumper colors available: (White Sand, Eggshell, Ivory, Desert Sand, Tan, Beige Desert, Cordovan, Sage Green, Hunter Green, Windsor Blue, Blue Bird and Black)



CRW-40

CRW-40 is designed to give a rich, warm feel to wall protection. As with CRW-20, CRW-30, CRW-60 and BR-5500, the flexible vinyl bumper is available in 12 standard colors or limitless custom color options.

Dimensions: 1-1/16"D x 4"H

Protection Level: Medium-Heavy

12 bumper colors available: (White Sand, Eggshell, Ivory, Desert Sand, Tan, Beige Desert, Cordovan, Sage Green, Hunter Green, Windsor Blue, Blue Bird and Black)

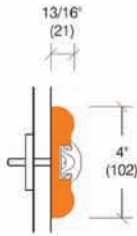

CRW-50

The beauty of wood combined with the tough durability of rigid vinyl (EBT-30) is the hallmark of our CRW-50 wall guard. Standard 70 vinyl color options, as well as any custom color you can dream up, allow for a broad range of design options.

Dimensions: 1-1/2"D x 3-3/4"H

Protection Level: Medium-Heavy

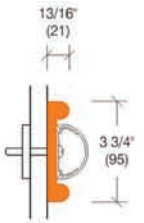

CRW-60

CRW-60 is our smallest wood option, with a classic chamfered profile. Durability is still a hallmark of this design, as it utilizes the same flexible bumper as other wood wall protection products.

Dimensions: 1-1/8"D x 3-1/4"H

Protection Level: Medium-Heavy

12 bumper colors available: (White Sand, Eggshell, Ivory, Desert Sand, Tan, Beige Desert, Cordovan, Sage Green, Hunter Green, Windsor Blue, Blue Bird and Black)

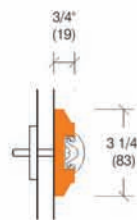

CRW-70

With a crescent profile and sturdy mounting bracket, our CRW-70 combines impact protection with a the warmth of real wood. End caps are easily created in the field to give this wall guard a clean and beautiful finished look.

Dimensions: 3/4" D x 2-1/4" H

Protection Level: Medium

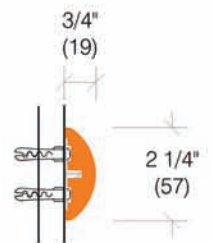

EB-25

This simple rounded profile can be used to protect walls, cashier islands, or nurses' stations from carts and equipment, or simply as an accent in your overall design.

Retainer: Continuous Aluminum

Dimensions: 1-1/16"D x 1-1/8"H

Protection Level: Medium

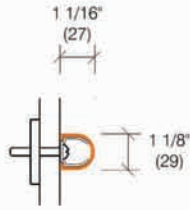

WG-22

A larger version of EB-25, WG-22 is perfect for use in many applications to protect against damage from carts, beds or chairs. The smooth finish helps maintain a clean aesthetic look.

Retainer: Continuous Aluminum

Dimensions: 1-3/4"D x 2"H

Protection Level: Medium

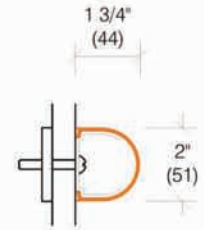

EBR-30,EBT-30

With either textured (EBT-30) or gloss (EBR-30) finishes, this classic, yet versatile shape is perfect as a chair rail, bumper rail, or just to provide a color accent.

Retainer: Continuous Aluminum

Dimensions: 1-1/8"D x 2"H

Protection Level: Medium

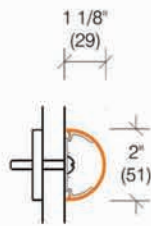

WG-225

A larger version of EB-25, WG-225 is perfect for use in many applications to protect against damage from carts, beds or chairs.

Retainer: Continuous Aluminum

Dimensions: 3/4"D x 2 1/4"H

Protection Level: Medium

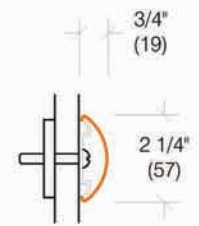

CR-3,4

Clear polycarbonate rub rails won't distract from the décor yet offer complete impact protection. Eight-foot lengths are available in 3" or 4" widths.

Dimensions: 5/16"D x 3" or 4"H

Protection Level: Medium

Colors: Clear

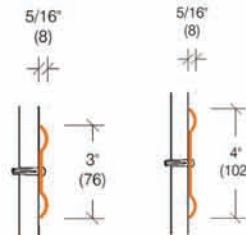

CRS-100, CRA-100, CRAT-100

Steri-Guard™ crash rails, available in stainless steel or aluminum, provide easily maintained, indestructible protection, for labs or hospitals where sterile environments are a concern.

Dimensions: 3-1/4"D x Height (2", 3", 4" and 6" standard rail heights available)

Protection Level: Heavy

Material: Aluminum or Stainless Steel

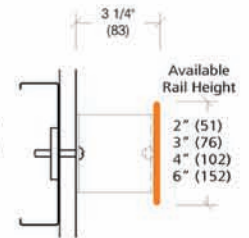

CRS-200

This stainless steel crash rail combines maximum impact protection with a clean, modern design. V-groove design adds rigidity and visual interest.

Dimensions: 1-1/2"D x 5-1/2"H

Protection Level: Heavy

Material: Type 304 or 430 Satinless Steel with #4 Satin Finish

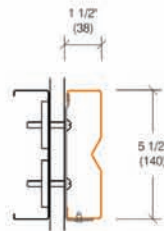

CRS-202

This stainless steel crash rail combines maximum impact protection with a clean, modern design. Stainless steel allows for easier cleaning.

Dimensions: 1-1/2"D x 5-1/2"H

Protection Level: Heavy

Material: Type 304 or 430 Satinless Steel with #4 Satin Finish

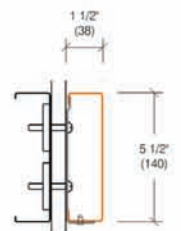

WALL COVERINGS

Pro-Tek® vinyl wall coverings are suited for a broad range of applications, from corridor wainscot and patient room walls, to back-of-house areas and slop sink backsplashes. Use as a finishing touch to complete a unified presentation in wall protection system designs. With a wide selection in thickness ranging from our .090" sheet, our wall covering can protect your walls, doors and cabinetry in any facility, and any application, all while providing added texture and color to whatever design scheme you choose. Available in a myriad of sheet sizes and rolls, 70 standard colors, and the ability to design a custom color, Pro-Tek® wall covering has the versatility to serve your needs.



WC-30,40,60,80,90

Standard size sheets are 4'x 8'. Also available are 3'x8', 3'x9', 3'x10', 4'x9', 4'x10', 2'x120', and 3'x120', as non-standard sizes with minimum quantities. 4'x120' is the standard size roll. Custom sizes also available.

*30 of our standard 70 colors have a minimum order quantity for WC-30. See our color selection guide for more detail.

Pawling's Pro-Tek® rigid wall covering is now available with a suede textured finish. Choose from our standard PVC or PETG compound, a variety of sheet sizes and rolls, any of our standard colors or custom color you can imagine.

WC-30   .030" (0.8)



WC-40   .040" (1.0)

WC-60   .060" (1.5)

WC-80   .080" (2.0)

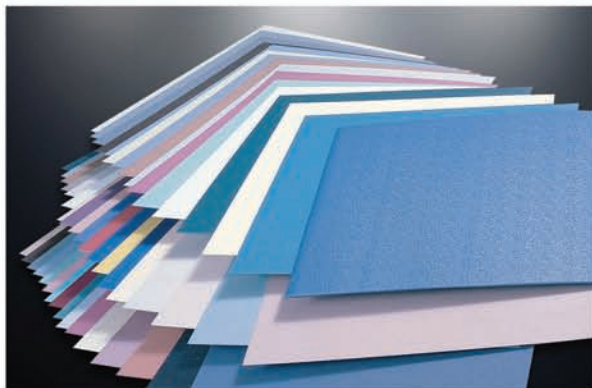
WC-90   .090" (2.3)



Product Code	Dimension	Fire Rating	Case Size	Available Colors
WC-30	.030"	Class A	30 pieces	 *
WC-40	.040"	Class A	20 pieces	
WC-60 	.060"	Class A	16 pieces	
WC-80	.080"	Unrated	12 pieces	
WC-90	.090"	Unrated	10 pieces	

WC-98,99,100,101



Top/End Caps

WC-98 for use with .030" - .060"
WCT-98 for use with .080" - .090"

Joint Cover

WC-99 for use with .030" - .060"
WCT-99 for use with .080" - .090"

Inside Corner

WC-100 for use with .030" - .060"
WCT-100 for use with .080" - .090"

Outside Corner

WC-101 for use with .030" - .060"
WCT-101 for use with .080" - .090"

Accessory Moldings Available in 8'- 0" and 10'- 0" lengths

Pawling offers a complete line of installation accessories. See our installation instructions for more detailed information on our website.

DOOR AND FRAME PROTECTION

It's easy to forget how vulnerable doors and entryways are to potential damage from equipment and pedestrian traffic. Pawling's door and frame protection helps reduce costly maintenance and repairs that come as a result of normal, day-to-day abuse. Available in a virtually unlimited variety of sizes, shapes and these accessories can be customized to further enhance your facility's décor.



PPV-40,60

Available in .040" (PPV-40) and .060" (PPV-60) thickness, these rigid vinyl push plates are available in 4" or 8" widths and can be applied with tape, adhesive or screws.

Dimensions: .040" thick or .060" thick
4"W x 12"H or 8"W X 12"H

Material: Vinyl



PPS-16

Use for extra protection; also excellent for laboratories and medical facilities where cleanliness is an important issue. Adhesive supplied for installation; drilling optional.

Dimensions: 16 gauge thickness; custom width and height

Material: Type 304 Stainless Steel with #4 Satin Finish

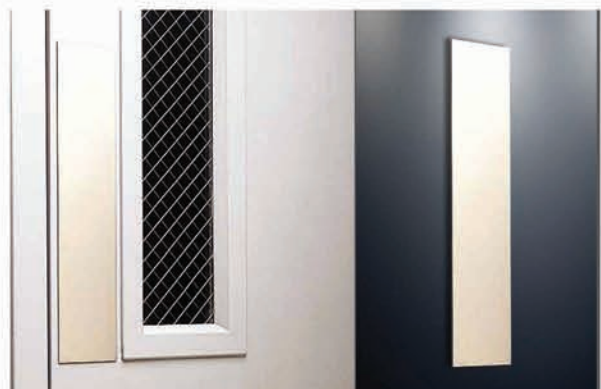



KPS-16

This heavy-duty kick plate is custom cut to ensure optimum performance. Adhesive supplied for installation; drilling optional. Also available with one or two bends.

Dimensions: 16 gauge thickness; and custom width and height

Material: Type 304, 430 Stainless Steel with #4 Satin Finish



KPV-40,60

Protect your door's most vulnerable area with this one-of-a-kind kick plate. Available in both .060" and .040" thickness, it can be customized with one or two bends to wrap around and protect the door edge as well or a wave cut feature for added design.

Dimensions: .040" or .060" thick in custom width and height

Material: Vinyl

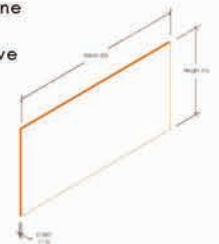

DFC-1

Manufactured to your custom requirements, this one-piece solid door frame guard is constructed to protect your entire door frame surface.

Dimensions: Custom formed to door frame

Material: Vinyl



DFGS-100

Stainless steel door jam guard protects doorways in a variety of biomedical and lab settings. Perfect to pair with our other stainless steel impact protection products.

Dimensions: 1" diameter, 42" and 48" standard lengths

Material: Type 304 Stainless Steel with #4 satin finish.

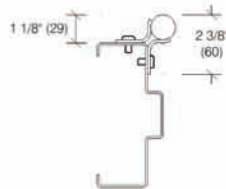

DFG-30

An aluminum retainer supports a rigid cover that affords added strength and protection. Installed with a 3" wing protection over your existing metal door frame.

Dimensions: 3" Wing - Height Varies

Material: Vinyl

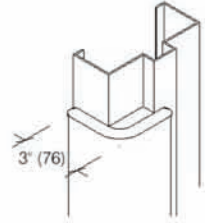

DE-138,175

Permanently shield your door edge to protect it from unsightly marring and excessive wear. DE-138 fits 1-3/8" doors; DE-175 fits 1-3/4" thickness.

Dimensions: U-shaped: 1-3/8" or 1-3/4" door width with 1" wings

Material: Vinyl

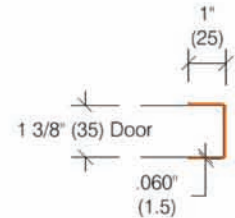

Rapid Response



Red E-Clip



Standard 70 Colors



Wood available in Oak, Maple, Cherry or Ash species and in our 6 Adirondack® Wood Stains



Uses Recycled Materials

DKP-10,12

The tapered design of the DKP-12 helps deflect collisions that can destroy a doorknob or cause serious injury. The cup-like shape of the DKP-10 provides complete protection.

Dimensions: DKP-10: 11-1/4"W x 6-3/8"H
DKP-12: 12"W x 3-3/16"H

Material: Vinyl

Colors: Ivory, Tan, Brown, Eggshell

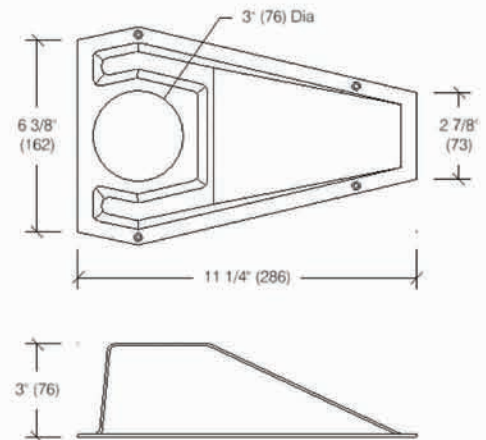

DES-190,193,290,293

Choose the profile that suits your needs. DES-190 and DES-193 protect the edge and one side of a door; DES-290 and DES-293 wrap around to protect the edge and two sides. Adhesive is supplied for installation (drilling optional).

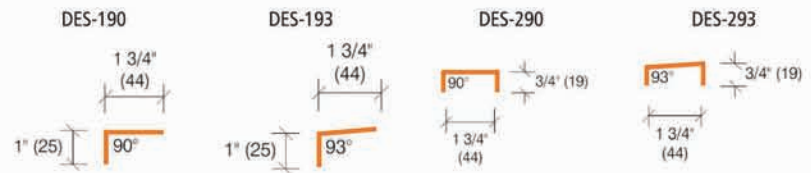

Product Code	Dimensions
DES-190	L-shaped: 1-3/4" x 1", 90°
DES-193	L-shaped: 1-3/4" x 1", 93°
DES-290	U-shaped: 3/4" x 1-3/4" x 3/4", 90°
DES-293	U-shaped: 3/4" x 1-3/4" x 3/4", 93°
Material	
Type 304 or 430 Stainless Steel with #4 Satin Finish	

EQUIPMENT AND CART BUMPERS

Protect more than your walls with our line of cart and equipment bumpers. Pro-Tek® protection goes the extra mile when you ensure the edges of your cart and equipment have the same safeguards as other areas of your facility. These versatile products can also be mounted on nurse stations, retail counters, or islands to protect from cart damage. Coordinate with other impact protection profiles to maintain a common theme and décor.



EB-1

The EB-1 series is available in three combinations of rigid and flexible vinyl, and aluminum. EB-1 has a flexible vinyl cover and aluminum channel.

Colors: Black, Tan, Ivory, Brown, Gray, Polar White
(matching end caps sold separately)

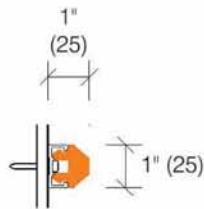

Dimensions	Material
1"D x 1"H	Flexible vinyl with aluminum channel



EBRF-1

EBRF-1 has a flexible vinyl cover and rigid vinyl channel. This combination allows for flexibility around columns.

Colors: Black, Tan, Ivory, Brown, Gray, Polar White
(matching end caps sold separately)

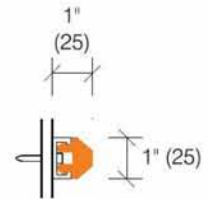

Dimensions	Material
1"D x 1"H	Flexible vinyl with rigid vinyl channel





EBRU-1

EBRU-1 has a rigid vinyl cover and rigid vinyl channel.

Colors: Black, Tan, Ivory, Brown, Gray, Taupe, Silver Gray, Linen White (matching end caps sold separately)

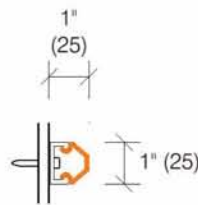

Dimensions	Material
1"D x 1"H	Flexible vinyl with rigid vinyl channel



WG-1,2

A cost effective alternative, the WG-1 and WG-2 series wall guards feature rigid vinyl inserts with a clear anodized aluminum channel for easy installation. Colors: Black, Gray, Beige Desert, Silver Gray, Linen White, Windsor Blue, Chinchilla, Eggshell, Teal

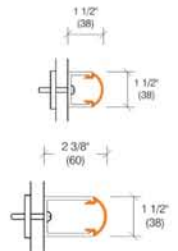

Product Code	Dimensions	Material
WG-1	1-1/2"D x 1-1/2"H	Rigid vinyl with aluminum channel
WG-2	2-3/8"D x 1-1/2"H	Rigid vinyl with aluminum channel



EB-10,21

EB-10 and EB-21 provide durable means to protect walls, carts, and other equipment. EB-10 conforms to equipment and wall contours with a steel channel, while the EB-21 comes with a aluminum retainer.

Colors: Black, Tan, Ivory, Brown, Gray, Polar White (matching end caps sold separately)

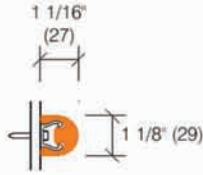
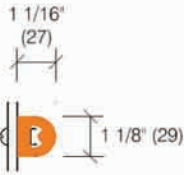

Product Code	Dimensions	Material
EB-10	1-1/16"D x 1-1/8"H	Flexible vinyl with steel insert
EB-21	1-1/16"D x 1-1/8"H	"Lock-in-place" flexible vinyl on aluminum retainer



MD-1,2

Excellent for marine and industrial applications, this series has surface areas of 2-3/4" or 4-7/16". These flexible vinyl bumpers provide the protection you need.

Colors: Black, Tan, Brown, Gray, White, Safety Yellow (Black end caps sold separately)

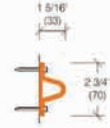

Product Code	Dimensions	Material
MD-1	1-5/16"D x 2-3/4"H	Single-Bulb Flexible Vinyl
MD-2	1-3/16"D x 4-7/16"H	Double-Bulb Flexible Vinyl



EB-8

EB-8 is made from flexible vinyl to provide durable corner protection for carts, cabinetry and countertops in a variety of colors.

Colors: Black, Ivory, Tan, Brown, Gray, Polar White

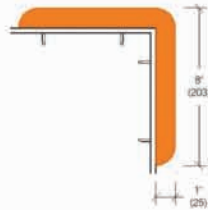

Dimensions	Material
1"D x 8"H	Molded flexible vinyl



EB-20

In a non-marking gray natural rubber, EB-20 will protect cart, cabinet and countertop corners from damage.

Colors: Gray

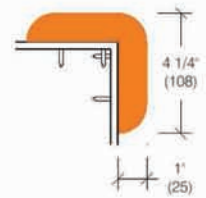

Dimensions	Material
4-1/4" W x 4-1/4" H x 1"D	Molded natural rubber





PARKING AND TRAFFIC SAFETY

Pro-Tek® products are designed to safeguard walls, corners, and columns exposed to vehicular traffic, and to control vehicle movement to reduce the incidence of personal injury to employees, customers, and pedestrians. Tell us what your impact protection and vehicle control issues are, and let us suggest a comprehensive system utilizing Pro-Tek® products to protect your facility. See for yourself the difference that Pro-Tek® products can make.



PB-1,2

Color: Safety Yellow, Handicap Blue, White, Black or Gray
 Weight: 32 lbs./Ea. (PB-1) 25 lbs./Ea. (PB-2) Stock Length: 70"
 Height: 3 1/2" (PB-1), 3 1/8" (PB-2)
 Material: 100% post-consumer, postindustrial recycled plastic
 Installations: Concrete: Lag Bolts
 Asphalt: Spikes/galvanized truss/plates for adhesive installation to concrete

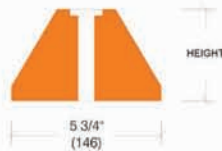

SBE-1025

Color: Safety Yellow
 Weight: 70": 28 lbs./Ea. or 106": 48 lbs./Ea.
 Material: 100% post-consumer, post-industrial recycled plastic
 Stock Length: 70", 106"
 Features: Economical, Easy portability
 Installations: Concrete: Lag Bolt/Butyl Tape
 Asphalt: Ground Spike/Butyl Tape

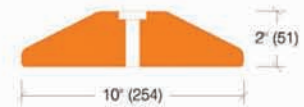

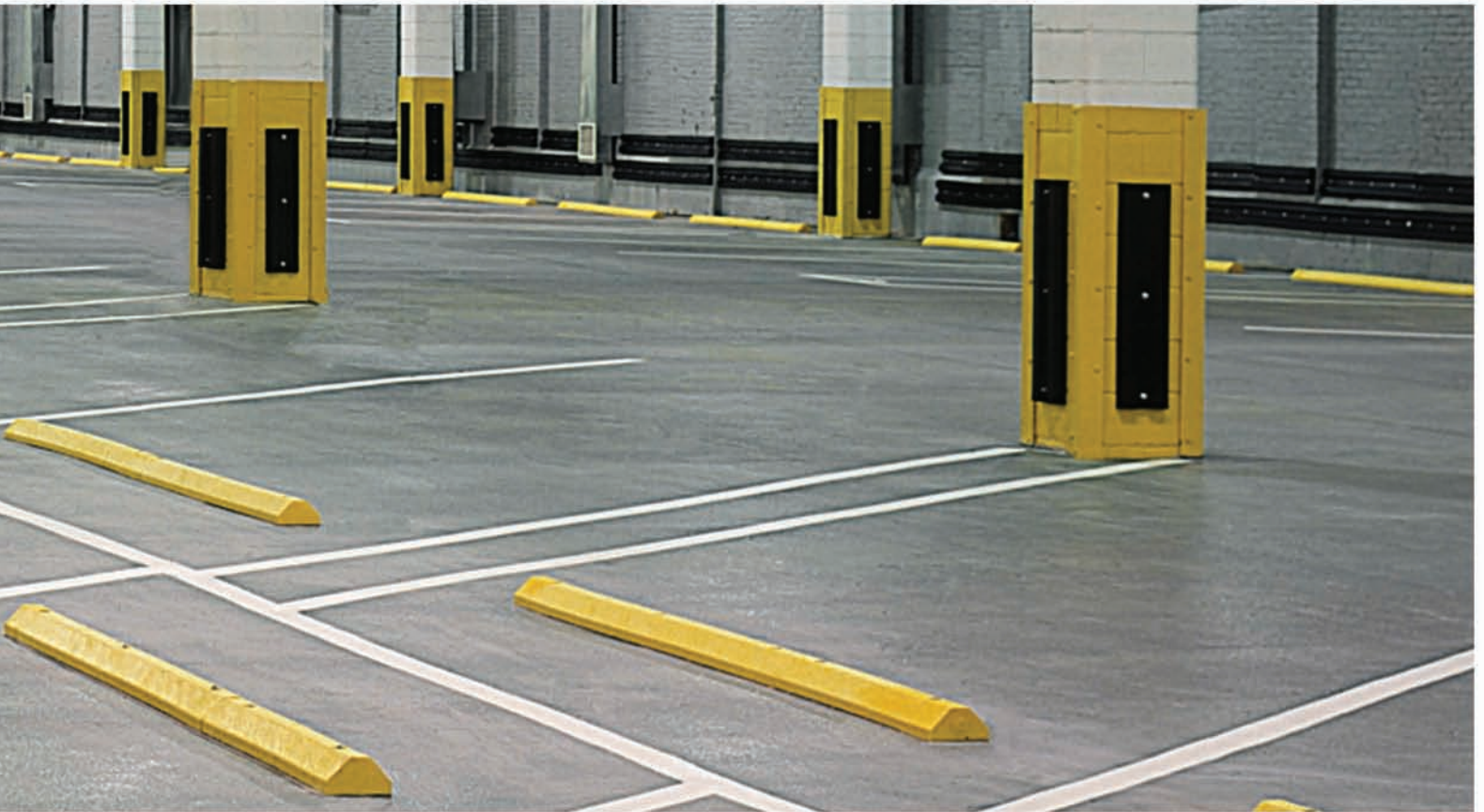

SBM-1225

Color: Orange
 Weight: 20 lbs./Each
 Material: Molded Urethane
 Stock Length: 4 ft.
 Features: Modular interlocking sections - ribbed surface.
 Installations: Loose-lay optional 3/16" proof coil chain.

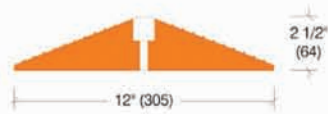

BOL-47,49

Color: Safety Yellow
 Weight: 3.0 lbs./Ea. (47), 4.0 lbs./Ea. (49)
 Material: Polyethylene with U.V. Stabilizers
 Stock Length: 50"
 Width: 5" (47), 6-7/8" (49)
 Installations: Clamp Band with Lock Screw

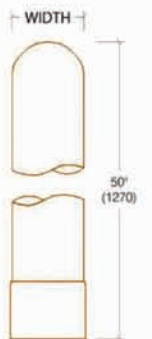

SC-5

Grooved base contoured to provide positive "gripping" action. Smooth surface prevents damage to rolls. EPDM rubber compound provides outstanding durability and weather resistance. Available in any length up to 12'0".

Colors: Black
Weight: 2.5 lbs./lin.Ft.

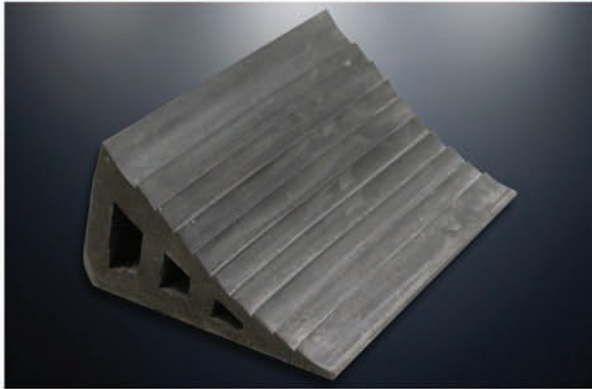
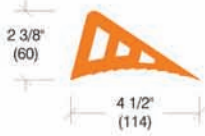

SC-9

Heavyweight design used to contain metal pipes, rolls, cable, and light trailers. Smooth surface prevents damage to outside layers of paper rolls. EPDM rubber compound provides outstanding durability and weather resistance. Available in any length up to 12'0".

Colors: Black
Weight: 4.5 lbs./lin.Ft.

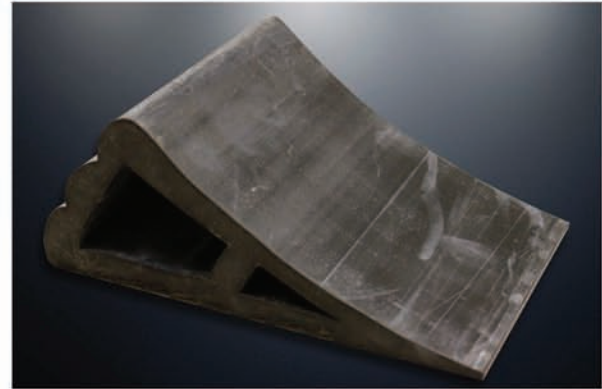

SC-10,13

Molded from a tough nylon-reinforced rubber compound the SC-10 and SC-13 are economical and durable. Recommended for use with heavy trucks, trailers and road equipment. The SC-10 has a standard eyebolt for attaching a chain, while the SC-13 comes standard with a larger "U"-bolt.

Colors: Black Weight: 9 lbs./Ea.

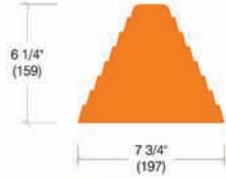

SC-2

All purpose style suitable for aircraft and medium sized trucks. EPDM rubber compound offers outstanding weathering characteristics and resistance to petroleum fuels, including jet fuel. High visibility orange hi-lite strips on 2 sides. Custom lengths up to 12'0".

Colors: Black, Safety Yellow
Weight: 9 lbs./lin.Ft.

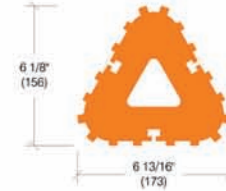

Rapid Response



Red E-Clip



Standard 70 Colors



Wood available in Oak, Maple, Cherry or Ash species and in our 6 Adirondack® Wood Stains



Uses Recycled Materials

SC-7

Versatile design for use with trucks, aircraft, large pipe, recreational vehicles and industrial dock locations. EPDM rubber compound offers outstanding weathering characteristics and resistance to petroleum fuels, including jet fuel. Custom lengths up to 12'0".

Colors: Black, Safety Yellow
Weight: 9 lbs./lin.Ft.

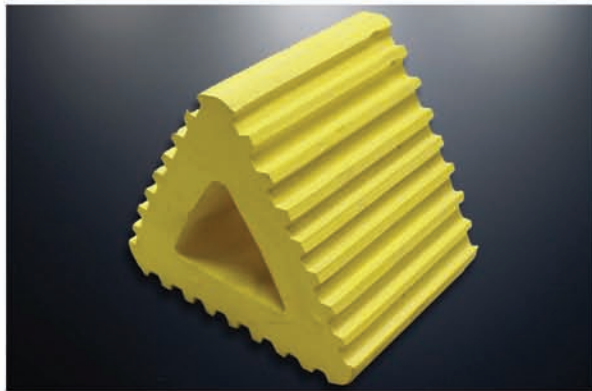
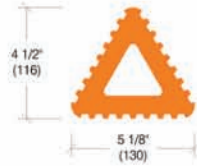

SC-3

Laminated recycled tire rubber pads assembled on 3/4" (19.1mm) bolts and compressed between 1/4" (6.35mm) steel plates. Positive grip - contoured to fit curvature of tire. Ideal for heavy utility trucks and equipment, large cable rolls and buses.

Colors: Black
Weight: 14 lbs./Ea.

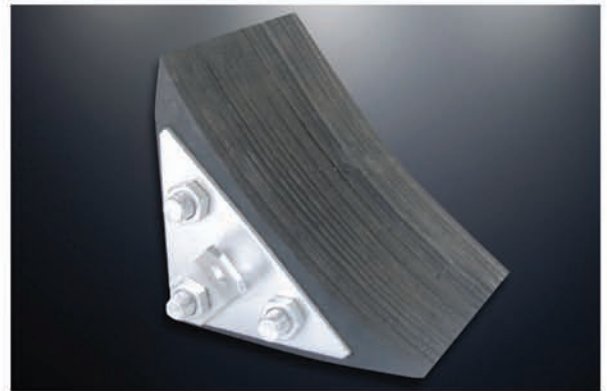
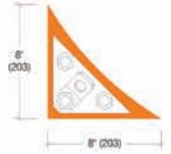

SC-6

Recommended for use with utility vehicles, pick-up trucks and recreation vehicles. Diamond plate face surface provides excellent grip.

Colors: Orange
Weight: 2 lbs./Ea.

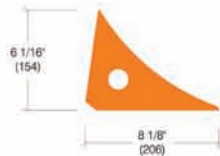

SC-12

Recommended for any "over-the-road" trucks/trailers. Lightweight, yet heavy duty.

Colors: Orange
Weight: 4 lbs./Ea.

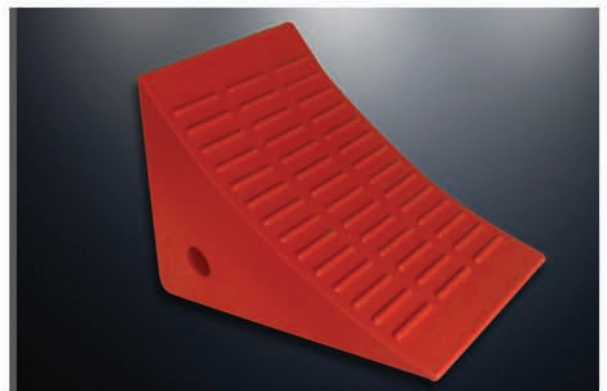
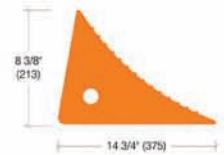

SC-17

SC-17: Rated for 120 ton trucks.

Colors: Orange
Weight: 28 lbs./lin. ft.

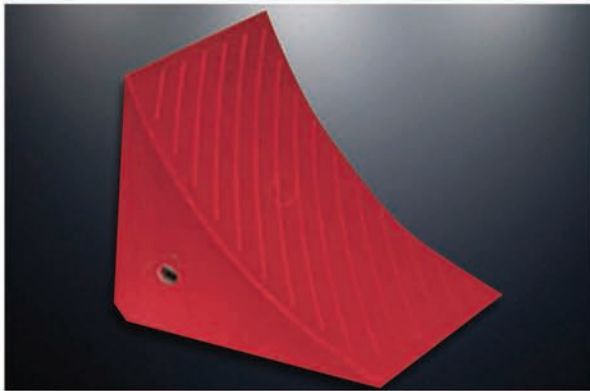
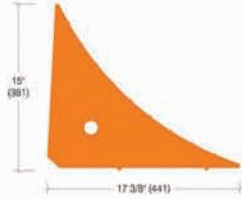

SC-18

SC-18: Rated for 240 ton trucks.

Colors: Orange
Weight: 45 lbs./Ea..

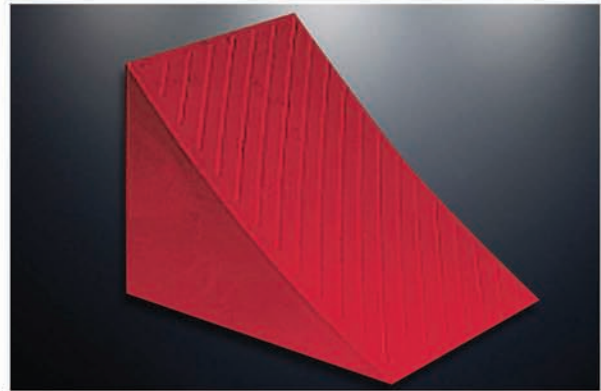
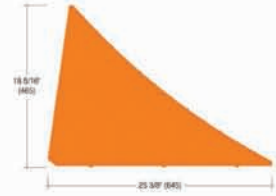

CH-1,2

CH-1: Weldless Chain - double loop. Low carbon steel. Finish: Bright zinc coated. Working load limit: 305 Lbs.

CH-2: 3/16" Grade 30-proof coil chain. Low carbon steel. Electro-galvanized. Working load limit: 800 lbs.

Product Code	Guage	Weight per ft.
CH-1	.124"	0.2 Lbs.
CH-2	.1875"	0.39 Lbs.





HEAVY-DUTY PROTECTION

Pro-Tek's® Heavy-Duty Wall Guard and Corner Guard series features superior protection from damage caused by all types of traffic. Our proprietary compounds provide chemical and UV stability suitable for most commercial and industrial applications. Whether it's a warehouse, parking garage, loading dock or other high-traffic area, Pro-Tek® Heavy-Duty Wall Guards will do the job right—protecting both your people and your property.



E-1

Used extensively in parking garages, industrial plants, warehouses, and building service areas, the E-1 can be wrapped around cylindrical columns of 18" diameter or greater. Use it to protect the entire environment—flat or curved.

Colors: Black

Dimensions	Material	Impact Protection
1-1/2" D x 8" H	EPDM Rubber	Ultra Heavy-Duty

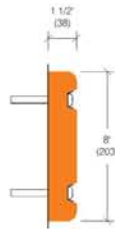

E-2

For good weather resistance and a non-marking surface, choose our urethane E-2 wall guard with matching molded end caps and outside corners.

Colors: Charcoal

Dimensions	Material	Impact Protection
1-3/4" D x 8" H	Urethane	Heavy-Duty

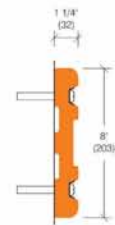



ER-25,45

ER-25 and ER-45 feature a solid block design for maximum impact resistance and chamfered edges for safety.

Colors: Black

Product Code	Dimensions	Material	Impact Protection
ER-25	2-1/8" D x 5" H	EPDM Rubber	Ultra Heavy-Duty
ER-45	3-1/2" D x 4-1/2" H	EPDM Rubber	Ultra Heavy-Duty

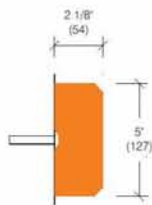

EB-15

Mounted on an aluminum retainer, the EB-15 offers excellent abrasion resistance and weather resistance. The retainer is easily installed with no visible hardware. Molded urethane end caps and outside corners provide a finished look.

Colors: Black

Dimensions	Material	Impact Protection
1" D x 2-1/4" H	EPDM Rubber	Heavy-Duty

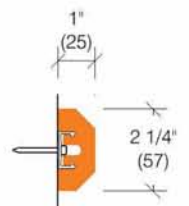

M-2

Similar to our E-1, but larger still for maximum surface protection (9"). This popular chamfered profile offers an added aesthetic value while still providing excellent protection for walls and vehicles.

Colors: Black

Dimensions	Material	Impact Protection
2"D x 9"H	EPDM Rubber	Ultra Heavy-Duty



MD-5

The MD-5 is designed for maximum roll action and provides good weather resistance. This extruded natural rubber wall guard with molded urethane end caps provides excellent protection in service corridors and other "back-of-house" applications.

Colors: Black, Gray

Dimensions	Material	Impact Protection
3"D x 5"H	Natural Rubber	Heavy-Duty

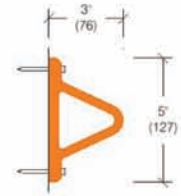

WT-30

Our wing-type bumper combines the impact absorption of a hollow cylindrical design with the ease of wing-mounted installation.

Colors: Black

Product Code	Dimensions	Material	Impact Protection
WT-30	3"D x 6"H	EPDM Rubber	Heavy-Duty

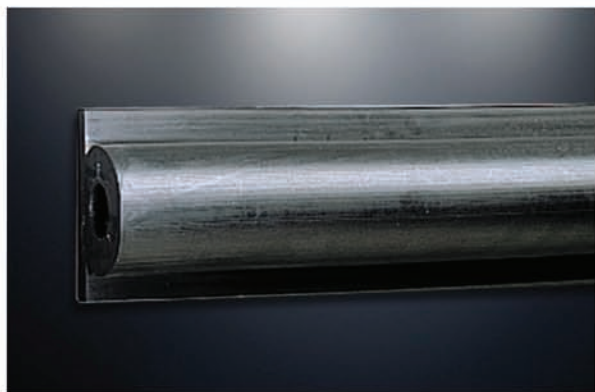

EB-4

The maximum cushioning effect of the EB-4 safeguards property in a variety of areas. Like the smaller version EB-15, it has good abrasion and weather resistance and is equally easy to install. Molded end caps and outside corners complete the installation.

Colors: Black

Dimensions	Material	Impact Protection
1-1/2"D x 4"H	Urethane	Medium

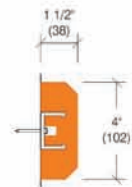

D-2,3,4,6

Vehicles will find extra cushioning from these D-shaped bumpers. Made from EPDM rubber, these bumpers range in size from 2" to 6"

Colors: Black

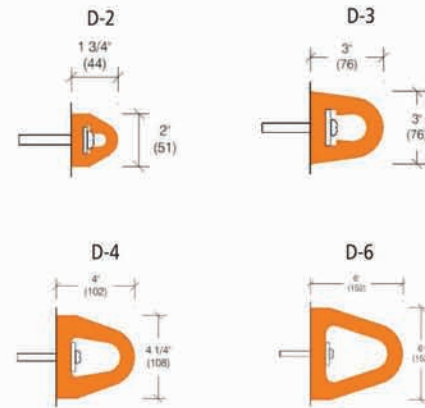
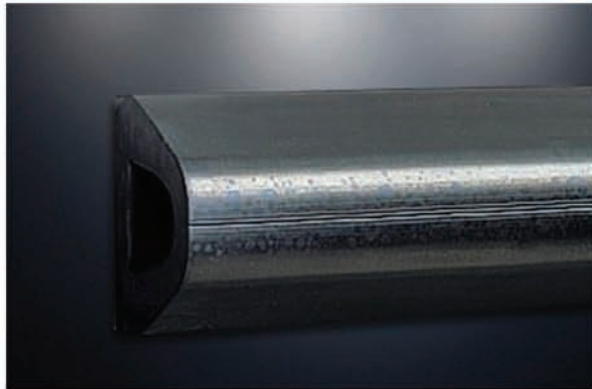

Product Code	Dimensions	Impact Protection	Colors
D-2	1-3/4" D x 2" H	Medium	Black, Gray
D-3	3" D x 3" H	Heavy-Duty	Black
D-4	4" D x 4-1/4" H	Ultra Heavy-Duty	Black, Gray, Yellow
D-6	6" D x 6" H	Ultra Heavy-Duty	Black

PEW-24,26,28,210,212

Pro-Tek® Earth™ 1-1/2" thick wall guards will protect your facility in even the heaviest abuse areas, such as factories, warehouses, and loading docks. Just like our 3/4" thick Pro-Tek® Earth™ products, these are made of 100% recycled high-density polyethylene (HDPE).

Colors: Pro-Tek® Earth™

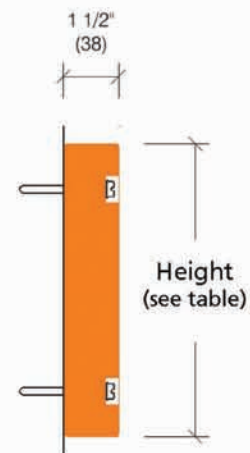
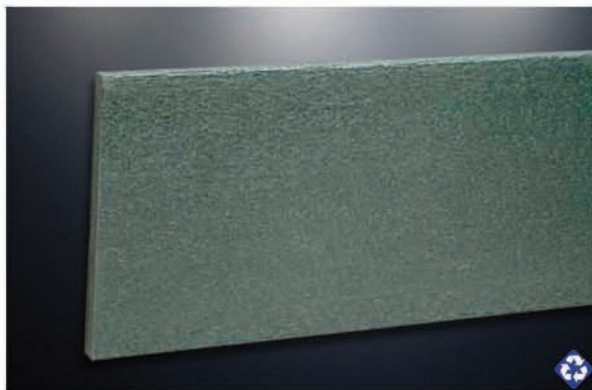

Product Code	Dimensions	Material	Impact Protection
PEW-24	1-1/2" D x 3-1/2" H	Recycled HDPE	Heavy-Duty
PEW-26	1-1/2" D x 5-1/2" H	Recycled HDPE	Heavy-Duty
PEW-28	1-1/2" D x 7-1/2" H	Recycled HDPE	Heavy-Duty
PEW-210	1-1/2" D x 9-1/2" H	Recycled HDPE	Heavy-Duty
PEW-212	1-1/2" D x 11-1/2" H	Recycled HDPE	Heavy-Duty

PEW-14,16,18,110,113,118

An environmentally friendly alternative to rubber, these 3/4" thick Pro-Tek® Earth™ profiles are excellent options for moderate to heavy-duty abuse areas, such as service corridors or "back-of-house" applications. Made of 100% recycled high-density polyethylene (HDPE).

Colors: Pro-Tek® Earth™

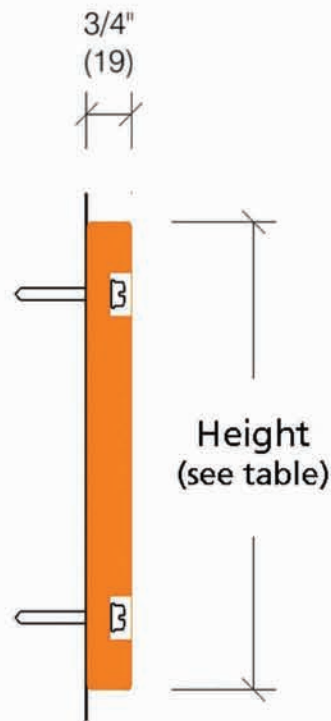
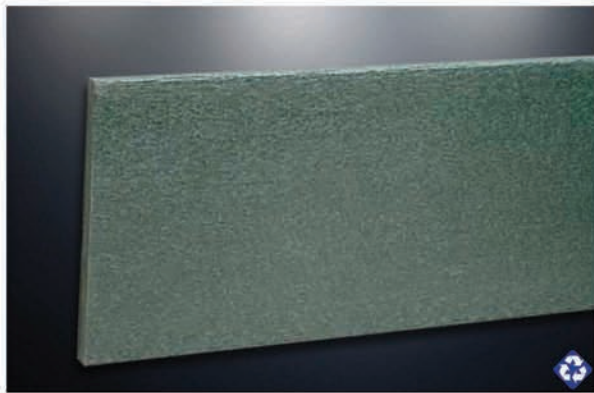

Product Code	Dimensions	Material	Impact Protection
PEW-14	3/4" D x 3-1/2" H	Recycled HDPE	Heavy-Duty
PEW-16	3/4" D x 5-1/2" H	Recycled HDPE	Heavy-Duty
PEW-18	3/4" D x 8" H	Recycled HDPE	Heavy-Duty
PEW-110	3/4" D x 9-1/2" H	Recycled HDPE	Heavy-Duty
PEW-113	3/4" D x 12-1/2" H	Recycled HDPE	Heavy-Duty
PEW-118	3/4" D x 18" H	Recycled HDPE	Heavy-Duty



HEAVY-DUTY CORNER GUARDS

When you need maximum impact protection in your commercial or industrial environment, turn to Pawling's line of Pro-Tek® Heavy-Duty Corner Guards. Protect columns in a retail environment and corners in your parking garage or storage facility. Whether it's loading docks, warehouses or in-plant offices that need protection, our Heavy-Duty Corner Guards will complete your design in a variety of wing sizes and colors.

CG-1

CG-1's natural rubber blend provides high-impact resistance in a non-marking material. Available in lengths from 4' to 12', our most popular heavy-duty corner guard can be used in any application, inside or out.

Colors: Gray
Material: Natural Rubber
Wing Size: 4-7/8"
Mounting: Adhesive or Mechanical

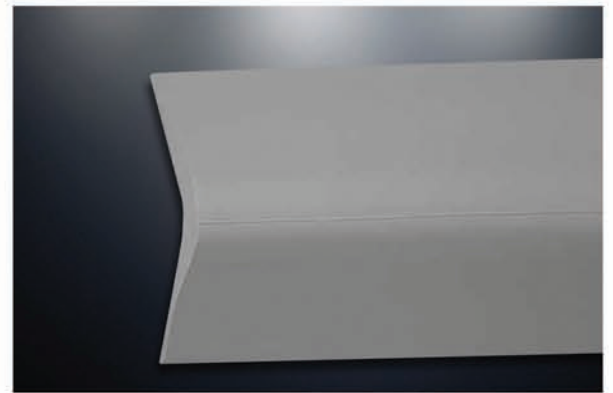
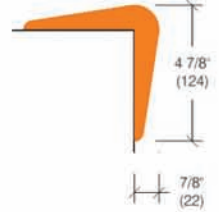

CG-2,2E

Made with SBR rubber or EPDM, this 4-5/8" wing corner guards offer durable protection in different environments. Use CG-2 for interior installations. CG-2E is perfect for interior or exterior environments.

Colors: Black
Material: SBR Rubber (CG-2)
EPDM Rubber (CG-2E)
Wing Size: 4-5/8" Mounting: Adhesive
or Mechanical

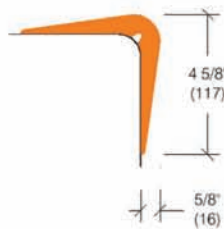

CG-3

CG-3 combines the reduced cost of flexible vinyl with a variety of color options to handle all kinds of heavy-duty impact protection applications.

Colors: Black, Ivory, Tan, Brown, Gray, Yellow, Polar White
Material: Flexible Vinyl
Wing Size: 2-1/2"
Mounting: Adhesive

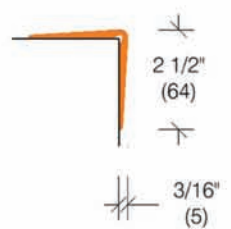

CG-4

CG-4 combines the durability and impact resistance of EPDM rubber with the convenience and added protection of a retainer/snap-on-cover installation. Comes complete with black urethane end caps for a finished look.

Colors: Black
Material: EPDM Rubber/Galvanized Steel
Wing Size: 3-3/8" Mounting: Mechanical Fasteners in Galvanized Steel Retainers

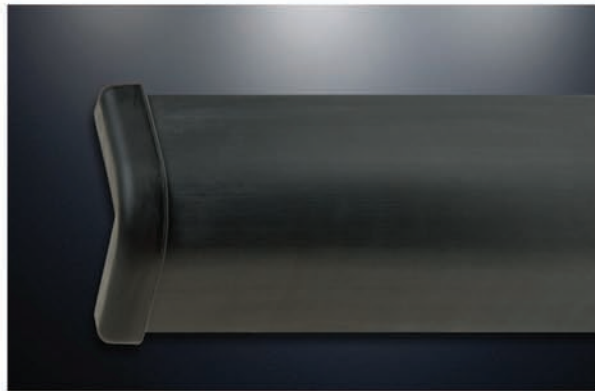
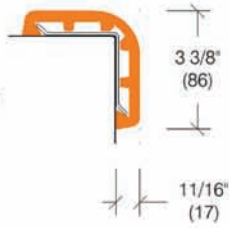

CG-5

Another natural rubber blend corner guard this time in a 4-3/4" wing size. CG-5 features a non-marking gray color and special chamfered corners in either 4' or 8' lengths.

Colors: Gray
Material: Natural Rubber
Wing Size: 4-3/4"
Mounting: Adhesive or Mechanical

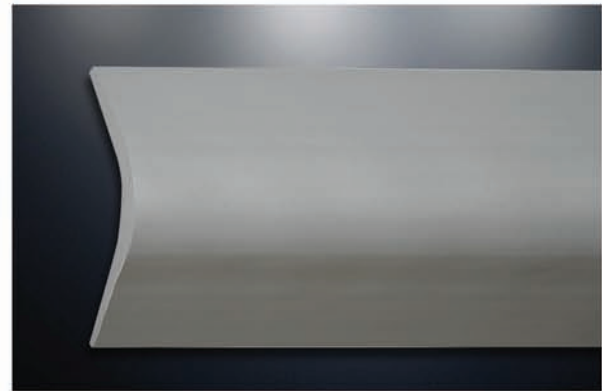
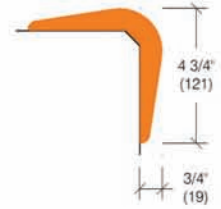

CG-9

CG-9 is our smallest and most inexpensive flexible vinyl corner guard, and is available in a seven different colors.

Colors: Black, Ivory, Tan, Brown, Gray, Yellow, Polar White
Material: Flexible Vinyl
Wing Size: 1-3/4"
Mounting: Adhesive

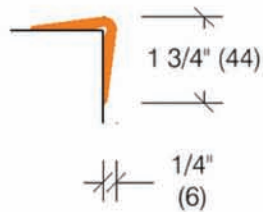

CG-15

Our largest flexible vinyl heavy-duty corner guard, the CG-15 has a 4" wing and provides durable protection for both interior and exterior installations.

Colors: Black, Tan, Brown, Gray, Safety Yellow
Material: Flexible Vinyl
Wing Size: 4"
Mounting: Adhesive

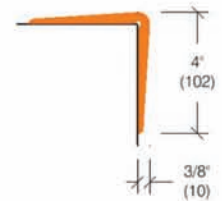



COLOR SELECTION GUIDE

STANDARD COLORS
PRO-TEK® EARTH
HEAVY-DUTY CORNER GUARDS AND
PARKING AND TRAFFIC SAFETY
ADIRONDACK® WOOD STAINS
POWDER COAT FINISHES

70 STANDARD COLORS

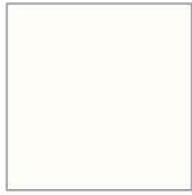

10
WHITE



648
MONTEREY



497
CHABLIS



718
SILKWORM



4
BROWN



301
LINEN WHITE



411
PUMICE



676
DOVER WHITE

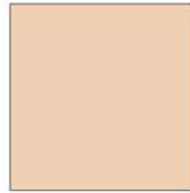

21
CAPPUCCINO



385
BEIGE DESERT



554
MISSION WHITE



555
PORCELAIN



268
DOESKIN



113
TOFFEE



269
ECRU

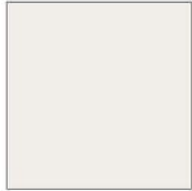

541
WHITE SAND



193
WHEAT



379
MOJAVE SAND



486
CAISSON



494
LAVENDER HEATHER



361
PEARL



2
IVORY



148
DESERT SAND



359
GINGER SPICE



381
DAWN



370
EGGSHELL

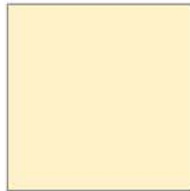

263
PALE YELLOW



3
TAN



288
MOCHA



373
ENGLISH ROSE



313
CHAMPAGNE



569
SAFFRON



682
KHAKI BROWN



694
CAFE AU LAIT



304
VICTORIAN ROSE

70 STANDARD COLORS



380
CORDOVAN



29
BLUE ICE



176
TAUPE



5
GRAY



96
PORTOBELLO



293
SEA FOAM



369
BLUE FOG



238
BONE



1
BLACK



234
PLUMBERRY



376
PALE JADE



382
STORMY BLUE



22
WOODLANDS



94
SUMMER FOG



421
DANDELION



371
SAGE GREEN



265
WINDSOR BLUE

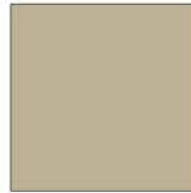

483
HARVARD GRAY



454
CHATEAU



255
MONARCH



377
TEAL



490
BLUE BIRD



297
CHINCHILLA



451
VAPORIZE



337
CARNIVAL RED



300
GROTTO



520
BRITTANY BLUE



210
SILVER GRAY



452
BLACK PEPPER

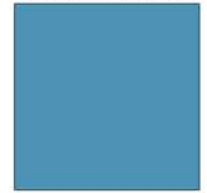

281
BERMUDA



156
HUNTER GREEN



583
ALEXIS BLUE



289
PEARL GRAY



316
SHORELINE



175
AMAZON

PRO-TEK® EARTH™



E24
BRIGHT WHITE



E23
CHERRY WOOD



E21
CEDAR



E14
WEATHERED WOOD



E13
SAND

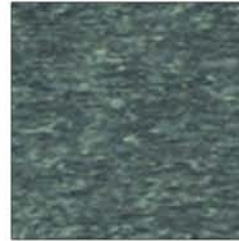

E6
TURF GREEN



E12
LIGHT GRAY

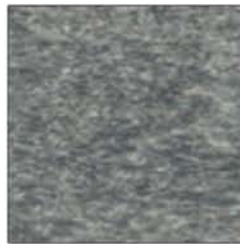

E10
GRAY



E1
BLACK

ADIRONDACK® WOOD STAINS



132
CLEAR



475
EARLY AMERICAN



476
LIGHT CHERRY



474
DARK CHERRY



478
WALNUT



380
CORDOVAN

HEAVY-DUTY CORNER GUARDS AND TRAFFIC SAFETY



10
WHITE

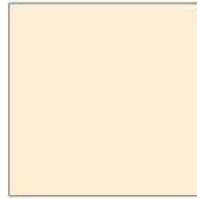

2
IVORY



4
BROWN



5
GRAY



1
BLACK



12
YELLOW



97
POLAR WHITE



8
HANDICAP BLUE



70
SAFETY YELLOW



104
ORANGE



3
TAN

POWDER COAT FINISHES



780
BRONZE HAMMERTONE



781
GRAY HAMMERTONE



782
SILVER HAMMERTONE



783
BLUE HAMMERTONE



784
GREEN HAMMERTONE



790
GRAY HAMMER



791
BLACK HAMMER

ATHLETIC FLOORING

Our unique Interlok® system provides secure, trip-free flooring without the costly installation of glue-down rubber floors. Choose from our traditional reversible tiles or our patented hidden interlocking tiles to create the look and feel you want in a variety of color options. Our Interlok® tiles are manufactured using a proprietary virgin rubber compound unique to the industry. Pawling's Pro-Tek® athletic flooring compound is formulated to provide the superior performance that recycled rubber flooring cannot match.



INTERLOK ® TILES

Our five choices of interlocking tile offer you the variety you need to create the environment and aesthetics you desire while also providing the optimal surface for your area. Create traffic patterns or basic designs by choosing two or more colors in the same tile design. Your imagination is the only limitation. See page 62 for specific color options for each tile.

Our five interlocking tiles all feature slip resistance that exceed ADA recommendations in wet and dry conditions and a Class 1 Flammability Rating (ASTM E-648/NFPA-253).

All of Pawling Pro-Tek® Athletic Flooring tiles require no adhesives. Our loose lay interlocking design provides for easy installation, saving you valuable labor costs. Compare our five styles of athletic tile to see which works best for your facility.

HL-155

Hid-N-Lok® II (HL-155) Our unique hidden interlocking system provides upscale styling with exceptional design flexibility. Great for both single or multi-color layouts, these versatile tiles are also available in a selection of popular school colors. A full list of all the color options can be found on page 62.

Height: 3/8"

Surface: Hammered

Static Coefficient of Friction: .093 Dry / Wet

Weight per tile: 12 lbs.

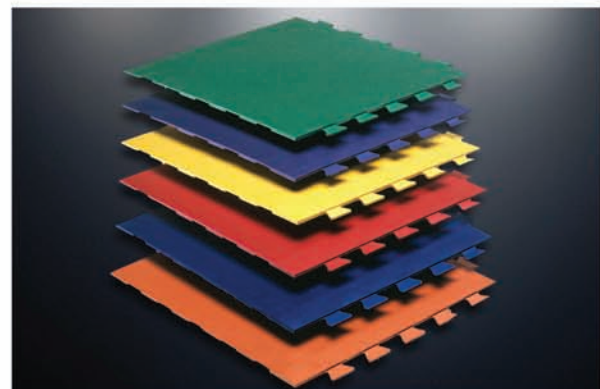
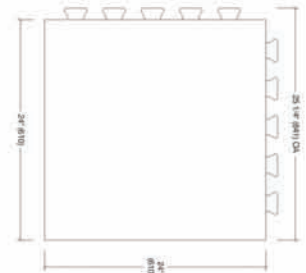



HL-100

Hid-N-Lok® (HL-100) Our attractive 5-1/2" square embossed surface pattern provides designer styling with maximum impact protection. Hidden interlocks make multi-color designs both attractive and functional - use for traffic patterns or to create your own unique design.

Height: 1/2"

Surface: Raised Squares

Static Coefficient of Friction: .095 Dry, .090 Wet

Weight per tile: 16 lbs.

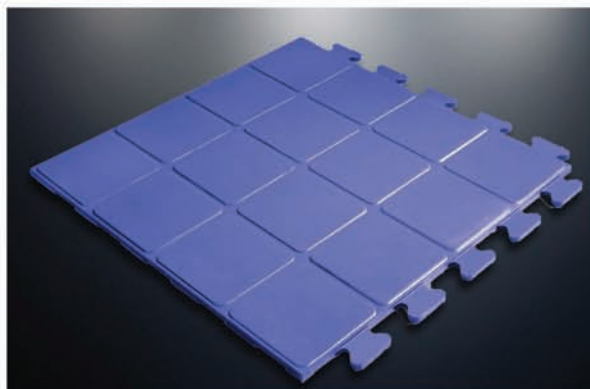
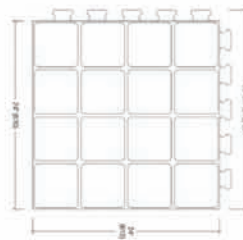

F-150

Flip-It® (FL-150) Double the life of your floor with our Flip-It tiles. Reversible interlocking tiles provide exceptional value, plus the ease of quick tile replacements. Works best in single color layouts.

Height: 7/16"

Surface: Reversible Hammered

Static Coefficient of Friction: .080 Dry, .088 Wet

Weight per tile: 12 lbs.

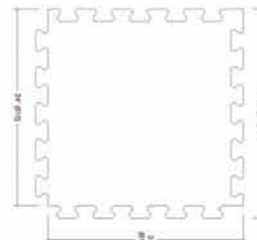

PL-200

Aerobic Tile™(PL-200) Our Aerobic Tile™ provides the cushioned resilience and wall-to-wall impact support aerobic students and instructors require. The knobbed underside provides additional "give" and comfort.

Height: 9/16"

Surface: Raised Nubs

Static Coefficient of Friction: .094 Dry, 1.04 Wet

Weight per tile: 14 lbs.

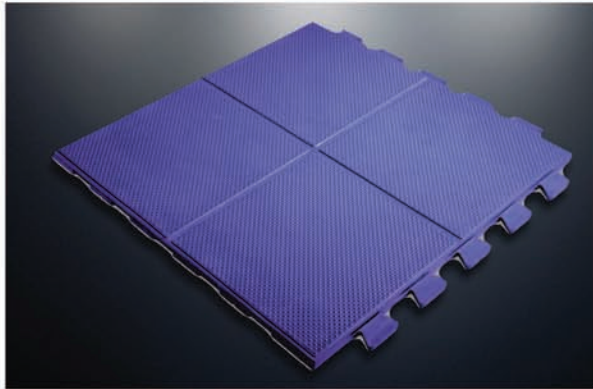
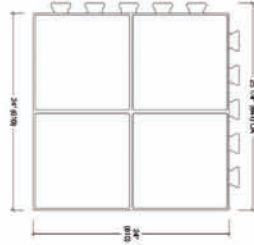

PL-100

Pro-Lok® (PL-100) Excellent for use on concrete slabs, our Pro-Lok® tile can be found in ice arenas, ski lodges and industrial plants. The unique knob-and-groove underside and loose lay interlocking tabs facilitate air flow in high moisture areas, thereby reducing the potential of mildew build-up.

Height: 7/16"

Surface: Raised Discs

Static Coefficient of Friction: .093 Dry / Wet

Weight per tile: 12 lbs.

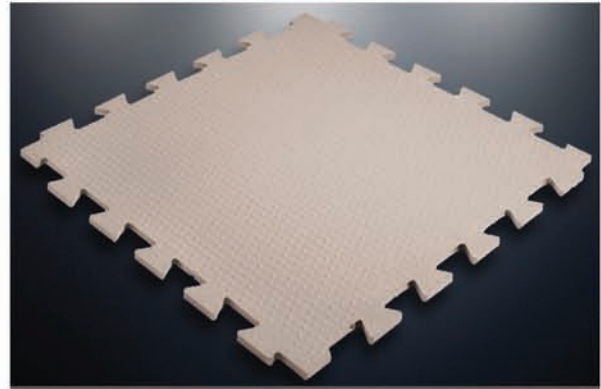
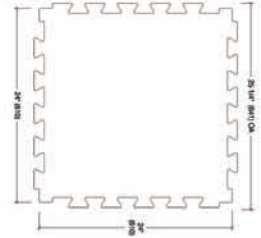

Rapid Response



Red E-Clip



Standard 70 Colors



Wood available in Oak, Maple, Cherry or Ash species and in our 6 Adirondack® Wood Stains



Uses Recycled Materials

RECYCLED RUBBER TILES AND PADS

For heavy-duty use in free weight areas, choose from Pawling's Protect-O-Pad and Punishment Pad Series. Our premium grade recycled rubber products are manufactured using a homogeneous pre-consumer compound that is revulcanized, allowing the flooring to maintain its dimensional integrity in heavy-duty fitness areas. These recycled products are non-absorbent and non-marking, require no adhesive to install and pass both MIL-W 5044C and UL 94HB tests for flammability.



P-40,50,60

These premium grade recycled rubber pads provide extra protection wherever it's needed - on hard floors, over carpeting, or over our Flip-It® and Hid-N-Lok® tiles in heavy-duty free weight areas. Our basic black 4' x 6' non-interlocking rubber pads are available in three thicknesses for a variety of fitness applications. These tiles are easy to trim on site to the exact dimensions you need.

Product Code	Size	Height	Weight	Recommended Uses
P-40	4'x6'	3/8"	50 lbs.	Under stationary equipment or as a protective walkway
P-50	4'x6'	1/2"	70 lbs.	Standard free weight applications
P-60	4'x6'	3/4"	105 lbs.	Heavy-duty free weight applications

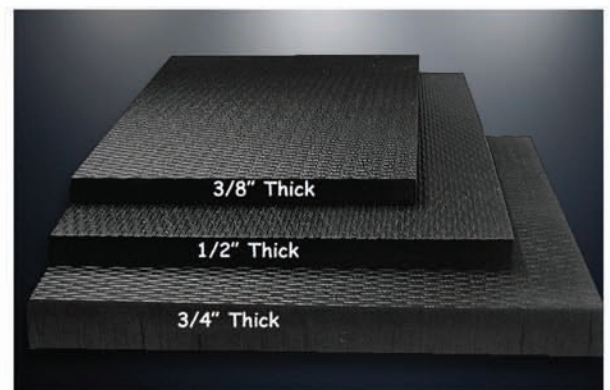

STANDARD INTERLOK® COLORS

FOR ALL INTERLOK® TILES



1
BLACK



3
TAN



7
TERRA COTTA

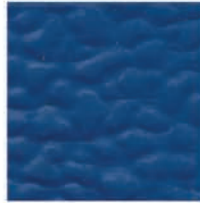

8
BLUE



38
CHARCOAL



176
TAUPE*

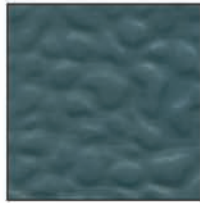

344
TEAL GREEN*

*UNAVAILABLE IN PL-100 STYLES

SCHOOL COLORS

AVAILABLE FOR HL-155 ONLY



308
EMERALD GREEN

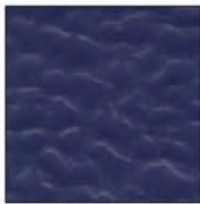

224
PURPLE



15
GOLD



14
CRIMSON

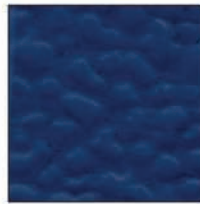

19
NAVY BLUE

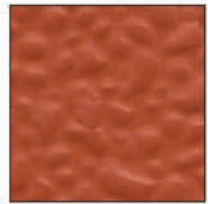

117
ORANGE

PROTECT-O-PAD

FOR P-80, 81 AND 82



1
BLACK

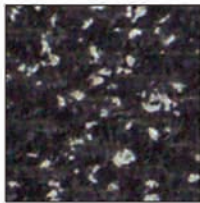

664
BLACK/GRAY SPECKS

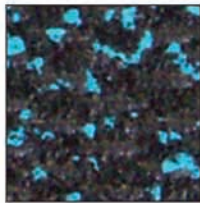

665
BLACK/BLUE SPECKS

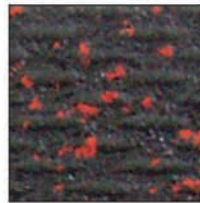

666
BLACK/RED SPECKS

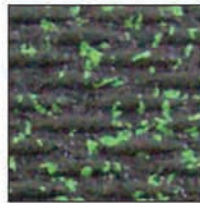

667
BLACK/GREEN SPECKS



ENTRANCE MATTING SYSTEMS

Pawling's line of Pro-Tek® Entrance Mats and Gratings offers a wide variety of options for a multitude of applications. A properly designed system plays a vital role in providing a safe, clean and attractive entryway and interior environment. With a variety of colors, frame materials, and layout options to choose from, Pro-Tek® Entrance Mats and Gratings can meet the needs of all commercial, industrial and institutional facilities.



ROL-DEK® SERIES

Protecting your building from moisture and debris starts with Pawling's complete line of custom Pro-Tek® entrance mats - like our Rol-Dek® Series. You can achieve a sleek, architectural look with a quality product that rolls up quickly for easy maintenance and cleaning. In three popular styles, the Rol-Dek® Series provides protection in moderate to heavy traffic areas and may be used in both recessed and surface applications.

All Rol-Dek® entrance mats feature:

- Easy cleaning, rolls back 180°
- Six different tread insert options create multiple combinations of colors and functions
- Custom fabrication, including angles, arcs/radii, and cutouts
- Continuous resilient vinyl cushion reduces clatter
- Optional square nosing for on-site trimming
- Optional beveled nosing for surface applications
- Rolling load test to 350 lbs./wheel
- EM-650/EM-800 fabricated from at least 70% recycled aluminum

EM-500

Dimensions: 7/16"

Rail Material: Vinyl

Rail Color/ Finishes: Black

Construction: Perforated vinyl hinge

Roll Back Capability: Yes
Rolling Load/Wheel: 350 lbs.

Traffic: Moderate Interior

Shipping weight will not exceed 1.9 lbs./sq. ft.

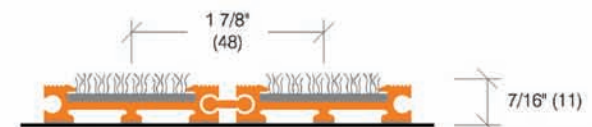

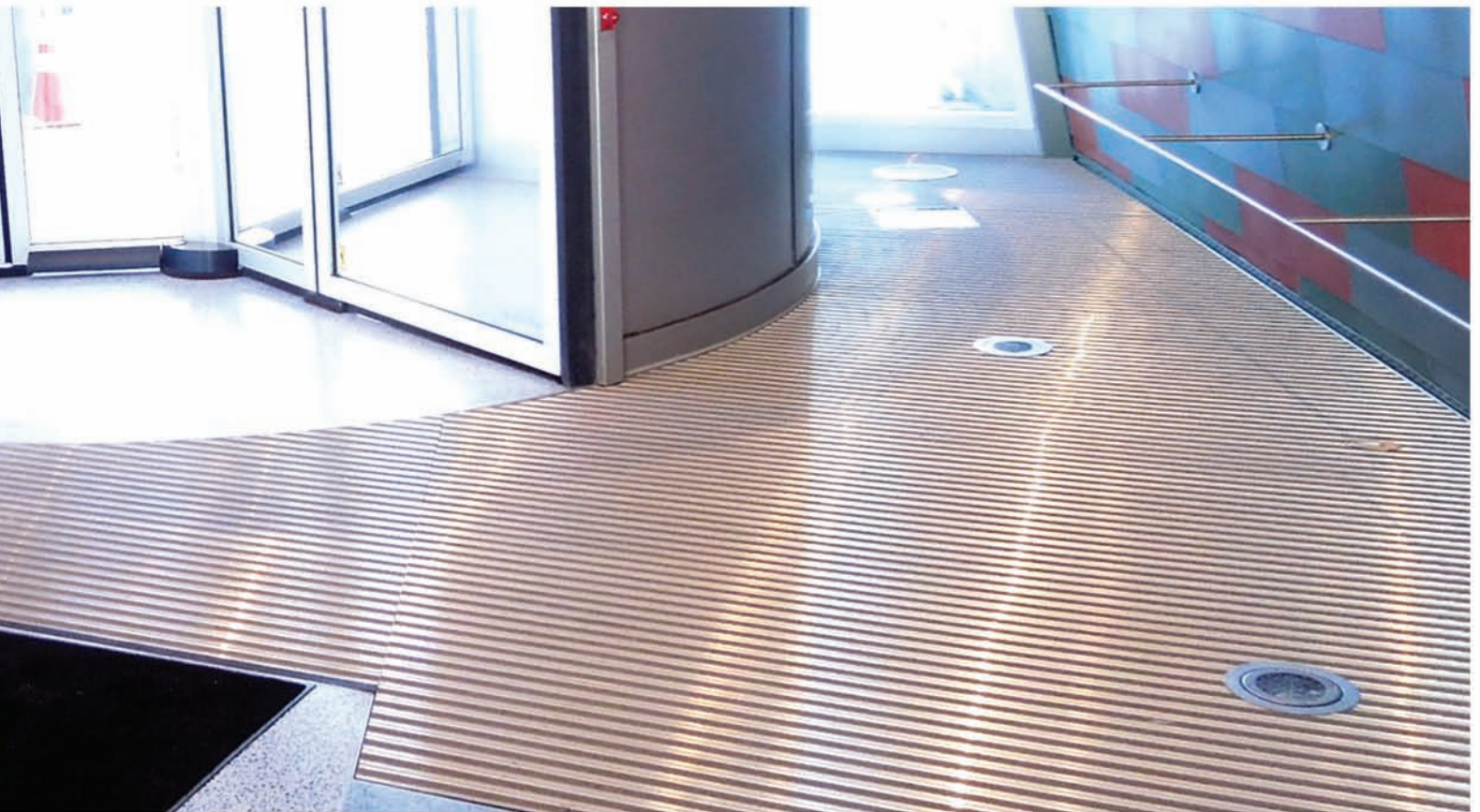

EM-650

Dimensions: 7/16"

Rail Material: Aluminum

Rail Color/ Finishes: Mill Finish, Clear Anodized, Bronze Anodized and Black Anodized

Construction: Perforated vinyl hinge
Roll Back Capability: Yes

Rolling Load/Wheel: 350 lbs.

Traffic: Heavy Interior or Covered Exterior

Shipping weight will not exceed 2.8 lbs./sq. ft.

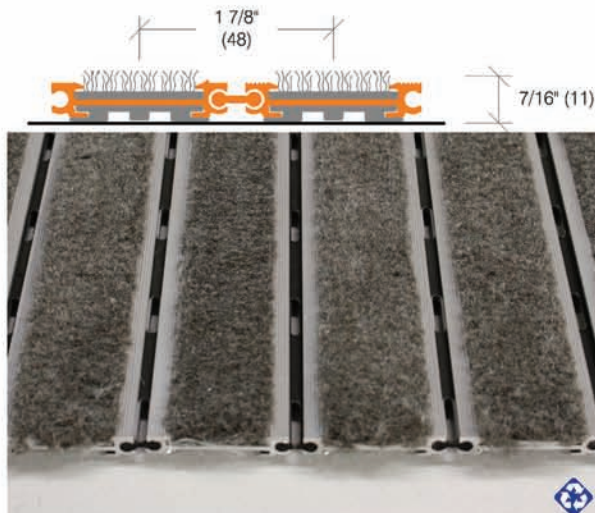

EM-800

Dimensions: 7/16"

Rail Material: Aluminum

Rail Color/ Finishes: Mill Finish, Clear Anodized, Bronze Anodized and Black Anodized

Construction: Solid or Perforated aluminum hinge
Roll Back Capability: Yes

Rolling Load/Wheel: 350 lbs.

Traffic: Heavy Interior or Exterior

Shipping weight will not exceed 3.0 lbs./sq. ft.

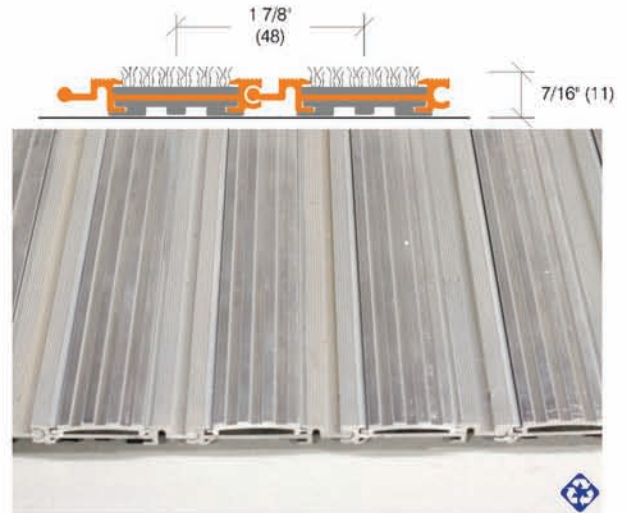

DRAIN-WELL® SERIES

Make a statement at your entrance with our heavy-duty Drain-Well® entrance mats. With three options to choose from, you're sure to find the one that meets your needs. Trapping grime is easier with our Drain-Well® Series - moisture and dirt scrapes off shoes and gets trapped beneath the surface. Available in four aluminum finishes, our Drain-Well® gratings will give you the aesthetic look you want with the entrance protection your building needs.

All Drain-Well® entrance mats feature:

- Six different tread insert options for multiple combinations of colors and functions
- Custom fabrications for specific needs such as arcs and patterns
- Continuous resilient vinyl cushion reduces clatter
- Standard level bed frame systems (RG-500/600 feature optional deep pit frame systems)
- Fabricated from at least 70% recycled aluminum

RG-300

Dimensions: 1-1/2"

Rail Material: Aluminum

Rail Color/ Finishes: Mill Finish, Clear Anodized, Broze Anodized and Black Anodized

Construction: Box beam rails fastened to support rails, spaced 12" on center with vibration proof fasteners
Roll Back Capability: No

Deep Pit Availability: Yes (RG-500)

Rolling Load/Wheel: 350 lbs.

Traffic: Heavy Interior or Covered Exterior

Shipping weight will not exceed 3.5 lbs./sq. ft.

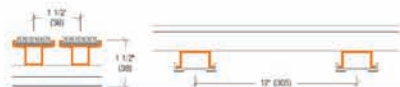

RG-250

Dimensions: 3/4"

Rail Material: Aluminum

Rail Color/ Finishes: Mill Finish, Clear Anodized, Broze Anodized and Black Anodized

Construction: Perforated vinyl hinge
Roll Back Capability: Yes

Deep Pit Availability: No

Rolling Load/Wheel: 1,000 lbs.

Traffic: Heavy Interior or Exterior

Shipping weight will not exceed 4.6 lbs./sq. ft.

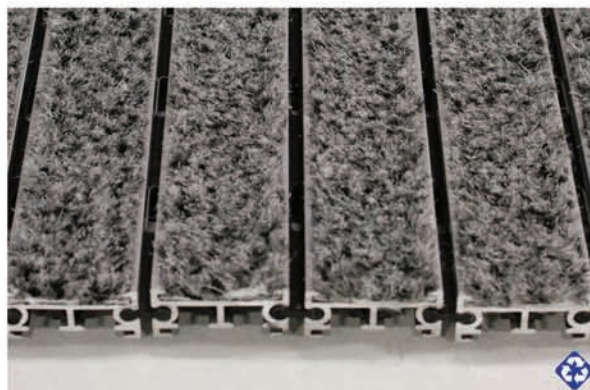
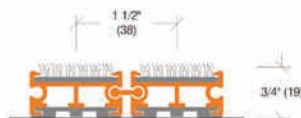

RG-400

Dimensions: 1-1/2"

Rail Material: Aluminum

Rail Color/ Finishes: Mill Finish, Clear Anodized, Broze Anodized and Black Anodized

Construction: Box beam rails fastened to support rails, spaced 6" on center with vibration proof fasteners
Roll Back Capability: No

Deep Pit Availability: Yes (RG-600)

Rolling Load/Wheel: 450 lbs.

Traffic: Heavy Interior or Covered Exterior

Shipping weight will not exceed 3.7 lbs./sq. ft.

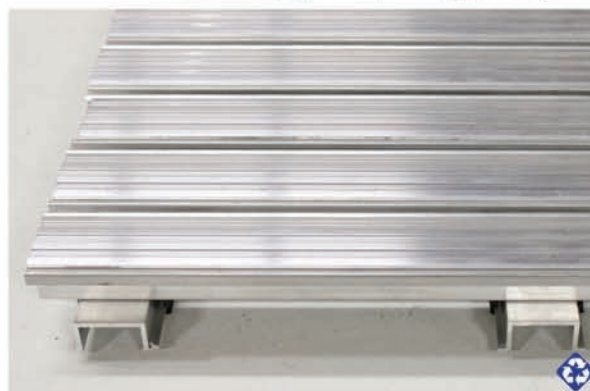

DRAIN-WELL® SERIES EM-70

Keep your facility clean and safe with our recycled rubber entrance mat. Our EM-70 Tire Mat series of entrance mats feature recycled rubber from aircraft tires. These rubber strips have woven nylon fibers for maximum absorption. Identical on top or bottom, the EM-70 can be flipped over for double the product life.

EM-70-CD

Closed construction with a double rubber strip

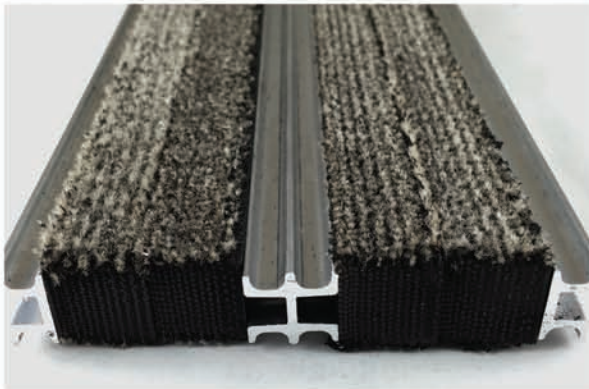

EM-70-OD

Open construction with a double rubber strip

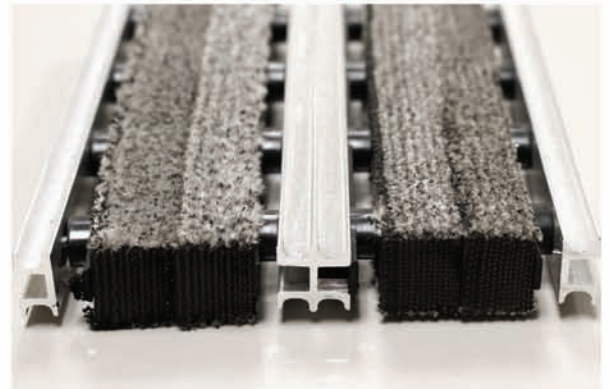
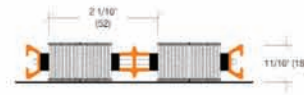

EM-70-CS

Closed construction with a single rubber strip

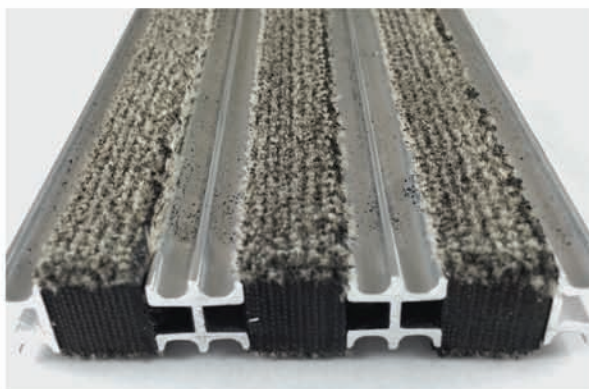

EM-70-OS

Open construction with a single rubber strip

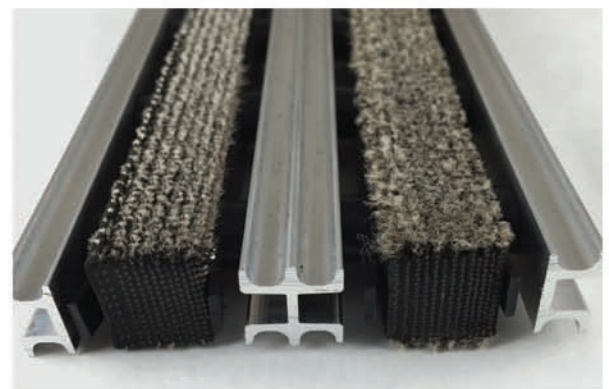
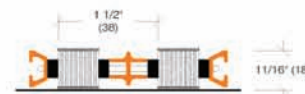

HEAVY-DUTY RUBBER ENTRANCE MATS

Pawling's Heavy-Duty Rubber Entrance Mats are designed to trap debris and minimize soil tracked into your building. Our heavy-duty rubber entrance mats feature excellent coverage for both interior and exterior high-traffic areas with slip resistance that exceeds ADA recommendations.

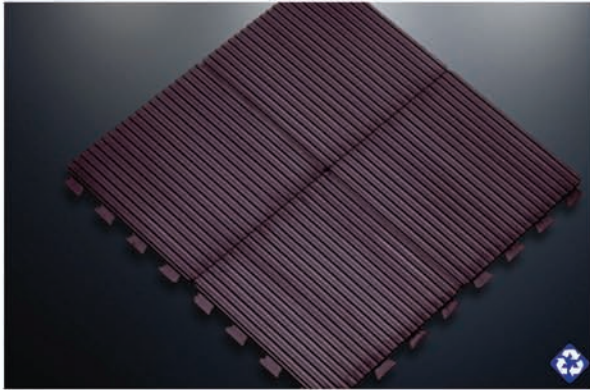

EM-205

Dimensions: 12" x 12" x 1/2"

Construction: Interlocking modular tiles

Material: Premium Rubber Compound

Color: Black

Installation: Loose Lay Interlocking

Static Coefficient of Friction Ratio (ASTM D-2047): Dry 0.97, Wet 1.02

Flammability: Passes FF-1-70 and FF-2-70

Weight: 2.4 lbs. / Ea.

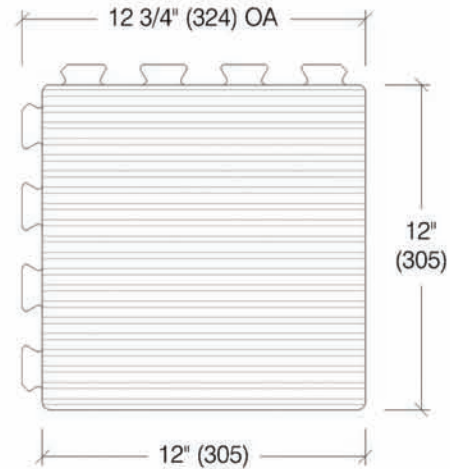

LT-50,51

Dimensions: 12" x 12" tiles (LT-50) 12" x 25' rolls (LT-51)

Construction: Rugged tire cord bonded to fiberglass backing

Material: 100% Recycled Rubber

Color: Muted Gray Earthtone

Installation: Glue down

Static Coefficient of Friction Ratio (ASTM D-2047): Dry 0.67, Wet 1.07

Flammability: Passes FF-1-70

Weight: 2.25 lbs. / tile (50), 2.25lbs. / sq. ft. (51)

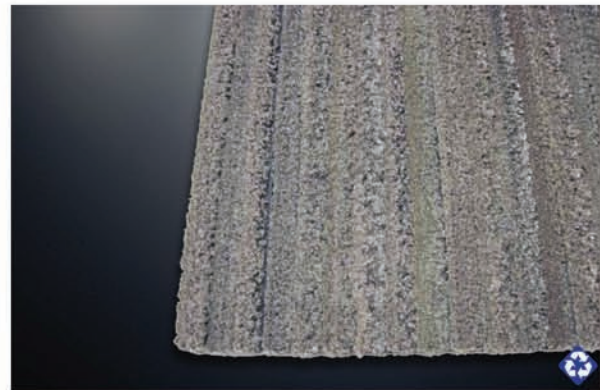
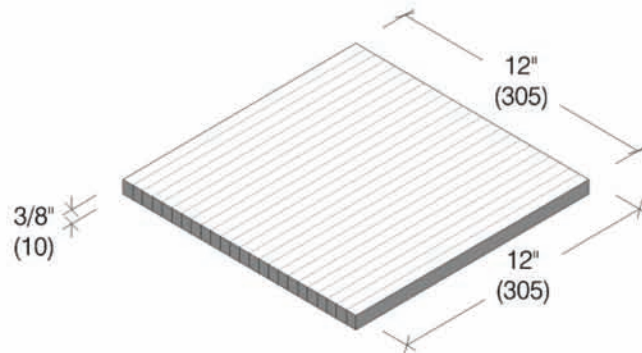

METAL GRATINGS

Our Pro-Tek® metal entrance gratings combine the beauty of metal with the exceptional strength of grid systems that are designed to stand up to the toughest traffic. Use in conjunction with our Maxi-Tuft Long Wear Carpet Matting to brush and remove moisture while providing a dramatic look for your entryway. With their smooth rollover capability, metal gratings such as our RG-200 are also excellent for applications involving wheelchairs or gurneys. Our metal gratings are well suited for both interior and exterior applications and are designed with a sculpted shape to increase slip resistance and provide a walking surface that will remove debris as it is carried into the building by foot traffic. The completed assembly provides openings between tread rails to allow dirt and debris to be captured and keep the interior of your building safe and clean.

All styles feature:

- Clean architectural lines for an elegant, high-tech appearance
- Safe, heel-proof design
- All-weather durability and easy cleaning
- Gratings can be temporarily removed for thorough cleaning
- Excellent choice for applications involving wheeled equipment

RG-700,710,720

Rail Finish/Material: Satin Stainless Steel

Construction: Welded assembly

Rolling Load/Wheel: 500 lbs.

Traffic: Heavy Interior or Exterior

Maximum Weight/sq. ft.: 3.0 lbs. (700), 4.0 lbs. (710), 6.0 lbs. (720)

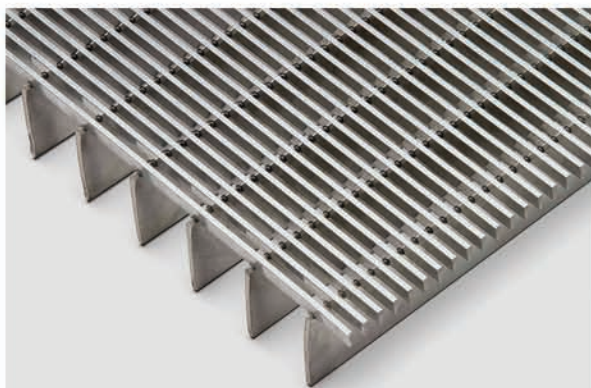

RG-200

Dimensions: 13/16"

Rail Material: Aluminum, Bronze

Rail material finishes: Mill Finish Aluminum (RGA-200), Satin Finish Bronze (RGB-200)

Rolling Load/Wheel: 350 lbs.
Traffic: Heavy Interior or Exterior

Construction: T-gratings fastened by steel tie rods and nylon insert lock nuts

Maximum Weight/sq. ft.:
Bronze: 7.25 lbs.
Aluminum: 2.6 lbs.

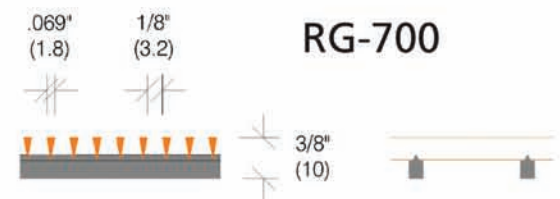
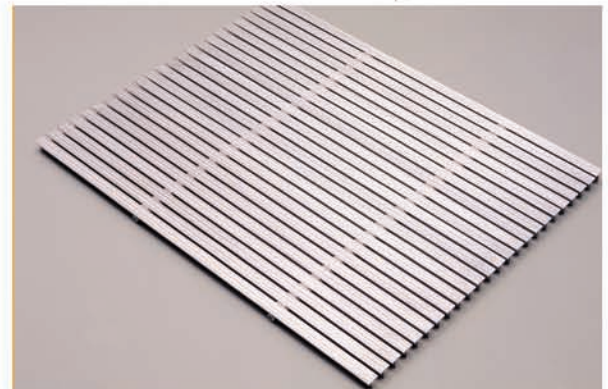
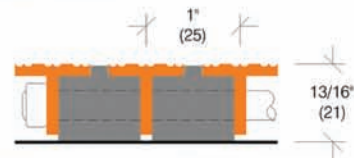

RG-700

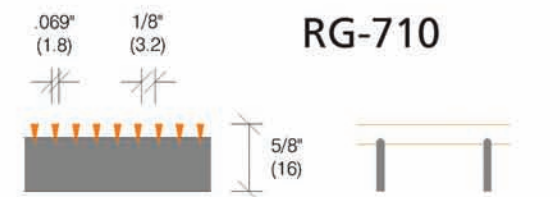

RG-710

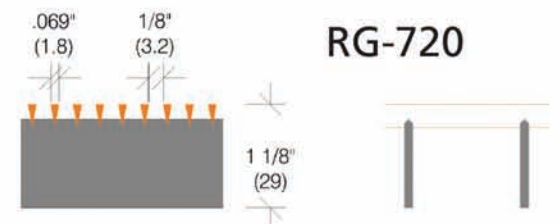

RG-720

HEAVY-DUTY CARPETS

Bring an upscale appearance to high-abuse or high-traffic areas with Pawling's Pro-Tek® Heavy-Duty Carpets. With a durable, rugged blend of heather fiber that provides excellent resistance to fading and UV light degradation, our heavy-duty carpets are perfect for interior and exterior applications. High traffic locations such as fitness clubs, country clubs, hotels and other lobby entrances will benefit from the non-woven needle-punched construction that makes Pawling's carpet more durable than conventional commercial carpet. Our Berber and Protector carpet lines offer attached vinyl beveled nosing for surface applications. All of Pawling's Berber, Protector and Jaguar carpets feature:

- A wide variety of colors to complement any décor
- Custom sizing
- Coarse fibers that effectively trap soil and debris
- Easy to clean durability
- Fiberbond construction that allows for factory or on-site custom cutting without unraveling
- Non-woven needle-punch construction
- DOC FF-1-70 & FF-2-70 flammability ratings
- Nonskid composite rubber backing

EM-40

Dimensions: 6'6" or 13'2" W x 1/2" H x 50' roll
 Pile weight: 52 oz. Sq. Yard
 Fiber Type: Polypropylene blend of 17-240 denier per filament fibers; soullfon dyed; UV stable
 Colors: 4 colors / See page 74
 Pattern: Ribbed
 Weight: .75 lbs./sq. ft.
 Traffic: Moderate to Heavy Interior/Exterior
 Installation: Loose lay or glue down
 Static Coefficient of Friction Ratio (ASTM C-1028-96): Dry 0.58, Wet 0.62

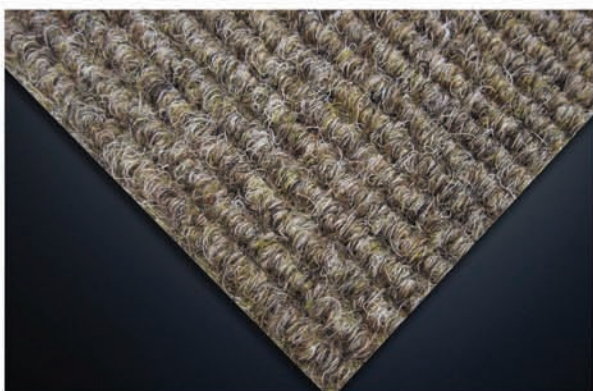

EM-20,22

Dimensions: (EM-20) 6'6" or 13'2" W x 1/2" H x approx. 50' roll
 (EM-22) 19'11/16" x 19'11/16" W x 1/2" H; 10 tiles per case
 Pile weight: 52 oz./sq. yard
 Fiber Type: Polypropylene blend of 17-240 denier per filament fibers; soullfon dyed; UV stable
 Colors: See page 74
 Pattern: Nubby Hobnail
 Traffic: Moderate to Heavy Interior/Exterior
 Installation: EM-20 Loose lay or glue down, EM-22 Glue Down
 Static Coefficient of Friction Ratio (ASTM C-1028-96): Dry 0.58, Wet 0.61
 Weight: .75 lbs./sq. ft.



EM-50

Dimensions: 6'6" or 13'2" W x 3/8" H x 68'11" roll
 Pile weight: 38 oz. Sq. Yard
 Fiber Type: Polypropylene blend of 17-240 denier per filament fibers; soullfon dyed; UV stable
 Colors: 2 colors / See page 74
 Pattern: Double Rib
 Weight: .54 lbs./sq. ft.
 Traffic: Moderate Interior/Exterior
 Installation: Loose lay or glue down
 Static Coefficient of Friction Ratio (ASTM D2047-82): Dry 0.53, Wet 0.62



VINYL BACKED MATS

Pawling's Pro-Tek® line of Maxi-Tuft Long Wear Carpet and Natural Cocoa Mats provides densely-tufted fiber construction for exceptional brushing and drying performance. The unique tetra-lobal shaped fibers of Maxi-Tuft collect three times the dirt of ordinary standard nylon type carpets. Used in combination with our Rol-Dek®, Drain-Well® and Metal Grating Series entrance mats, Maxi-Tuft will provide the best combination of style and performance to keep your entryways beautiful for years to come.



EM-701

Height: 3/8"
 Dimensions (approximate): 6'7" x 82'
 Fiber Type: 100% Polyamide Nylon: 80 and 40 Dtex, Blend tetra-lobal filters
 Colors: Black or Charcoal
 Construction: Tufted/cut pile
 Traffic: High Interior
 Static Coefficient of Friction Ratio (ASTM D-2047): Dry 0.87, Wet 0.87
 Flammability: DOC FF-1-70; Class 1
 Weight: .65 lbs./sq. ft.

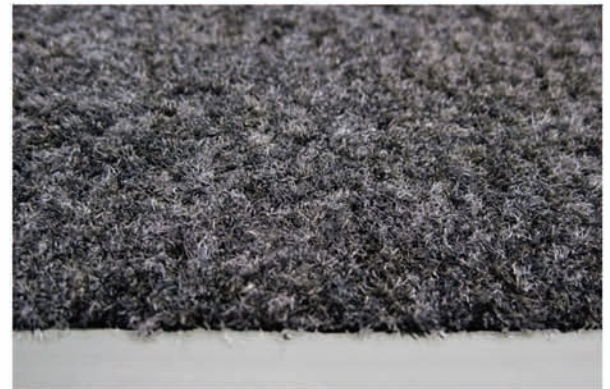

EM-300,301,302

Height: 5/8" (300), 3/4" (301), 1" (302)
 Dimensions (approximate):
 EM-300 Natural: 78" x 39' 4" roll
 Brown/Charcoal: 78" x 41" roll
 EM-301/302 Natural only: 78" x 39' 4" roll
 Fiber Type: Natural Cocoa Fiber Yarn (coir)
 Colors: Natural (EM-300 also in Charcoal or Brown)
 Construction: Indian Cocoa fiber bonded to solid vinyl backing
 Traffic: Moderate to high interior
 Static Coefficient of Friction Ratio (ASTM D-2047): Dry 0.75, Wet 1.09
 Flammability: DOC FF-1-70 and FF-2-70
 Weight: EM-300 1.75 lbs./sq. ft.
 EM-301 2.00 lbs./sq. ft.
 EM-302 2.50 lbs./sq. ft.



VINYL ENTRANCE MATS

Pawling's Pro-Tek® vinyl entrance mats combine performance and style to suit any entry requirements. The LM-100 and LM-400 both feature safe, heel-proof drainage holes for a comfortable and slip-resistant entry surface. Exceeds the ADA recommended standards for slip resistance in wet and dry areas (0.67 Dry and 0.89 Wet per ASTM D-2047).

LM-100,400

Dimensions : 7/16" thickness (custom length and width)

Material: Flexible Vinyl

Colors: 12 (Custom Logo Available)

Construction: Flexible vinyl links connected by 12 gauge spring steel wires. Square and beveled nosings available.

Optional: Open Weave (LM-400)

Traffic: Moderate to Heavy Interior or Exterior

Installation: Loose Lay

Flammability: Class 1 (ASTM E-648)

Weight: 2.3 lbs./sq. ft. (100), 1.8 lbs./sq. ft. (400)



7/16" (11)



7/16" (11)

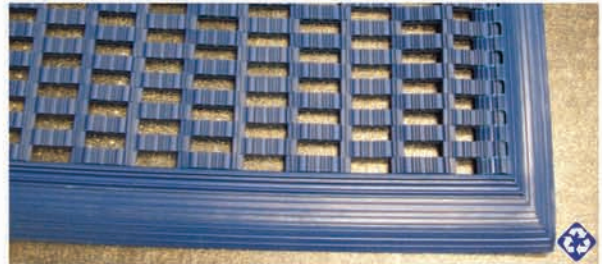

Custom Logo Mats

This economical, jet dye printed nylon mat, has a washable nitrile rubber backing. Using a 4 color dye printing process, Quadra print can create almost any color and image that you require.

Dimensions : 3' x 5' with logo

Material: Jet dye printed nylon

Weight: 6.5 Lbs.



ENTRANCE MATTING COLOR SELECTION GUIDE

RIGID-BACK NYLON CARPET (SNC)

- HEATED INTERIOR ABSORPTION APPLICATIONS
- EFFECTIVE MOISTURE/DUST CONTROL IN LIGHT TRAFFIC AREAS



38 CHARCOAL



511 PLUM BEIGE



512 DESERT PLUM



513 TERRA CLAY



514 BRITISH GREEN



515 HARBOR BROWN



596 WINTER SLATE



518 LANCASTER GRAY



519 NEAR BLACK



592 CHROME



516 MUSHROOM



595 TRUFFLE

BRISTLE FILAMENT (BFO)

- INTERIOR OR EXTERIOR SCRAPING/ABSORPTION APPLICATIONS
- AGGRESSIVE BRUSH ACTION FOR MAXIMUM CLEANING
- SUPERIOR INDOOR/OUTDOOR PERFORMANCE

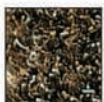

4 BROWN



519 NEAR BLACK



18 SAND



38 CHARCOAL



344 TEAL

ALUMINUM ABRASIVE (AA)

- EXTERIOR OR INTERIOR SCRAPING APPLICATION
- NOT RECOMMENDED FOR HEAVY, PIVOTING ROLLING LOADS
- CARBORUNDUM CHIP SURFACE PROVIDES EXCEPTIONAL ALL WEATHER TRACTION FOR PEDESTRAIN TRAFFIC

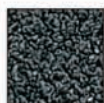

1 BLACK

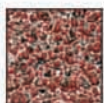

7 TERRA COTTA



5 GRAY



4 BROWN

RIGID CORRUGATED VINYL (RCV)

- INTERIOR OR EXTERIOR SCRAPING/ABSORPTION APPLICATIONS
- LOW MAINTENANCE/EXCELLENT SCRAPING
- MODERATE ROLLING LOADS



1 BLACK



7 TERRA COTTA



289 PEARL GRAY



374 ASH BROWN



385 BEIGE DESERT

CORRUGATED ALUMINUM (CA)

- EXTERIOR OR INTERIOR SCRAPING APPLICATION
- MOSTLY DURABLE
- REQUIRES LEAST MAINTENANCE
- ONLY INSERT RECOMMENDED TO ACCOMMODATE "PIVOTING" ROLLING LOADS
- RECOMMENDED FOR SUPERMARKET AND WHEELED CART APPLICATIONS



405 MILL FINISH ALUMINUM

MAXI-TUFT LONG WEAR (MLW)

- HEATED INTERIOR OR EXTERIOR SCRAPING/ABSORPTION APPLICATIONS
- THREE TIMES THE DURABILITY OF STANDARD NYLON CARPET
- EXCELLENT CRUSH/ABRASION RESISTANCE
- AVAILABLE IN FULL ROLLS FOR MATCHING CUSTOM-SIZED MATS (EM-701)



1 BLACK



38 CHARCOAL

ENTRANCE MATTING COLOR SELECTION GUIDE

EM-20 & 22 BERBER



EM-40 PROTECTOR



EM-50 JAGUAR

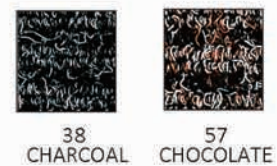

LM-100 & LM-400 PARCO-LINK



EM-300, 301, 302 COCOA MAT

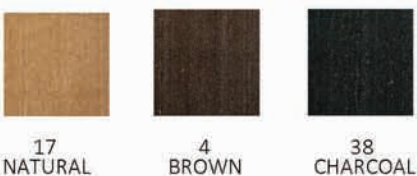

EM-701 MAXI-TUFT

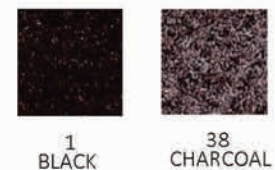





OUR VISION AND WARRANTY

Pawling Corporation pledges to employ all its resources to focus on customer satisfaction and continual improvement. We strive to provide superior quality products and services that meet or exceed your expectations. We want to be your first choice for a wide variety of architectural products. Pawling stands behind every sale with our Limited Lifetime Warranty. We warrant all standard catalog products against defect in materials and workmanship when installed in conformance with the Pawling Corporation Installation Instructions.

22 Nelson Hill Road, P.O. Box 200, Wassaic, NY 12592

Tel: (800) 431-3456 or (845) 373-9300

Fax: (800) 377-4403 or (845) 373-7827



For detailed technical drawings and information on all Pawling products including CADs and specs, visit www.pawling.com

©2016 The Pawling Corporation

Pawling Corporation reserves the right to discontinue or modify a design without prior notice.