

# RG-600 Drain-Well<sup>®</sup> Maxi-Tuft Carpet Insert

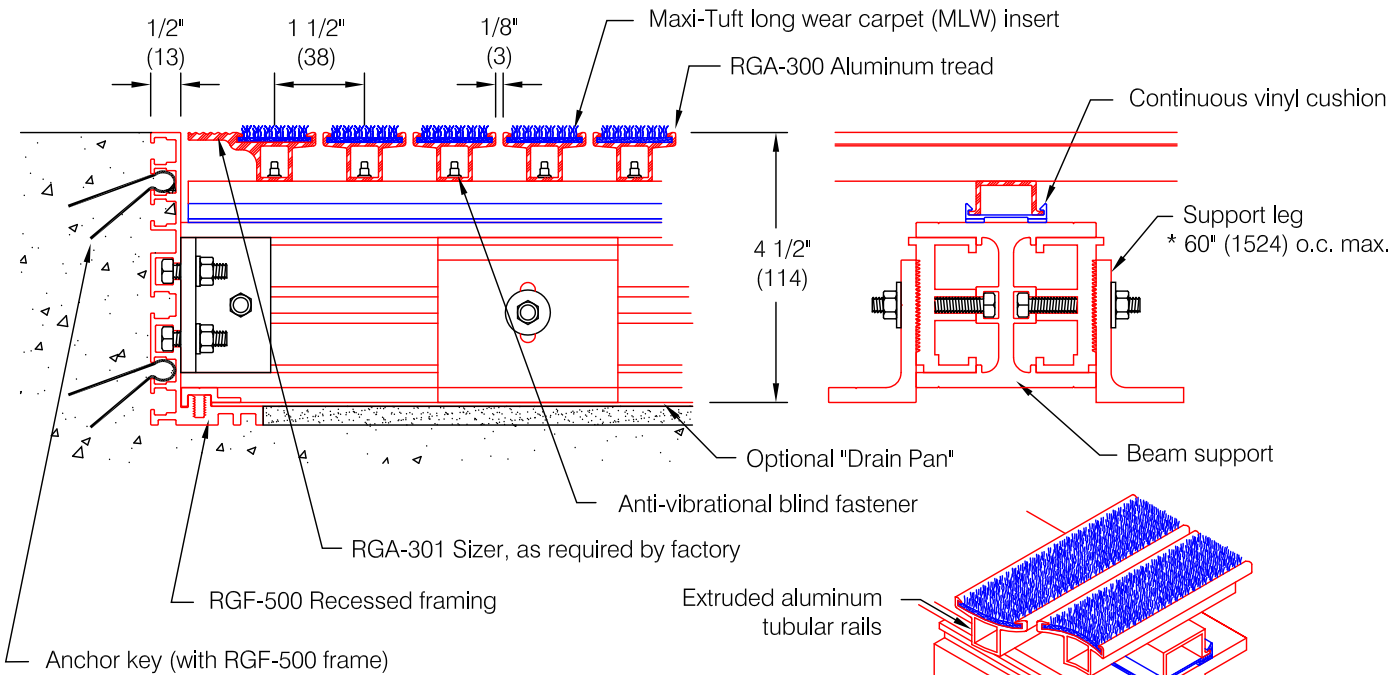

**Features:**

- Extruded aluminum treads and cross supports alloy 6105-T5
- Continuous dual-durometer vinyl cushion for superior noise reduction
- 4 1/2" (114) deep for increased drainage ability
- Tubular tread rails for increased strength
- Anti-vibrational fasteners for sturdy, long-life service
- Single section width to 144" (3658)
- Space dyed, 100% polyamide nylon, tetra-lobal fibers, 5/32 (4) pile height, 30 oz/sq yd
- Static Coefficient of Friction (ASTM D-2047-82) Dry: 0.49, Wet: 0.77
- Optional clear anodized drain pan (actual drain by others, if required)

**Finishes:**

- Aluminum tread:
  - Mill finish (standard) #405
  - Medium bronze anodized #404
  - Clear anodized #403
  - Black anodized #462
- Aluminum cross supports:
  - Mill finish #405
- Maxi-Tuft long wear carpet insert:
  - Select from manufacturer's color samples

**Sectioning information:**

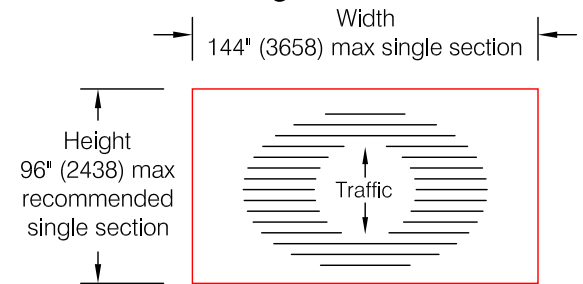

\* Mats over 48 square feet may require sectioning as determined by the factory

**Note On Dimensions:**

\* Pawling requires that exact mat opening dimensions be provided. Factory will fabricate mats 1/4" (6) smaller than exact opening dimensions to allow for proper fit.

\* Support leg (used for mats exceeding 60" (1524) front to back)

Pawling Corporation reserves the right to discontinue a design or modify an existing design without prior notice

Customer :	Project :	ED.33.12c
Architect :	Sales Rep :	